

MODULE -1

INTRODUCTION

Definition

The discipline associated with the control of generation, storage, collection, transfer and transport, processing and disposal of solid waste in a manner i.e. in accordance with best principle of public health, economics, engineering, conservation, aesthetics and other environmental considerations and that is also responsive to public health.

Solid waste: Solid waste is all the waste arising from human and animal activities that are normally solid and that are discarded as useless or unwanted.

- It encompasses the heterogeneous mass of throwaways from residences and commercial activities as well as more homogenous accumulation of a single industrial activity.

Land pollution – “It refers to any physical or chemical alteration of land, rendering it incapable of beneficial use without treatment.”

notes4free.in

Functional Elements of Solid waste management:

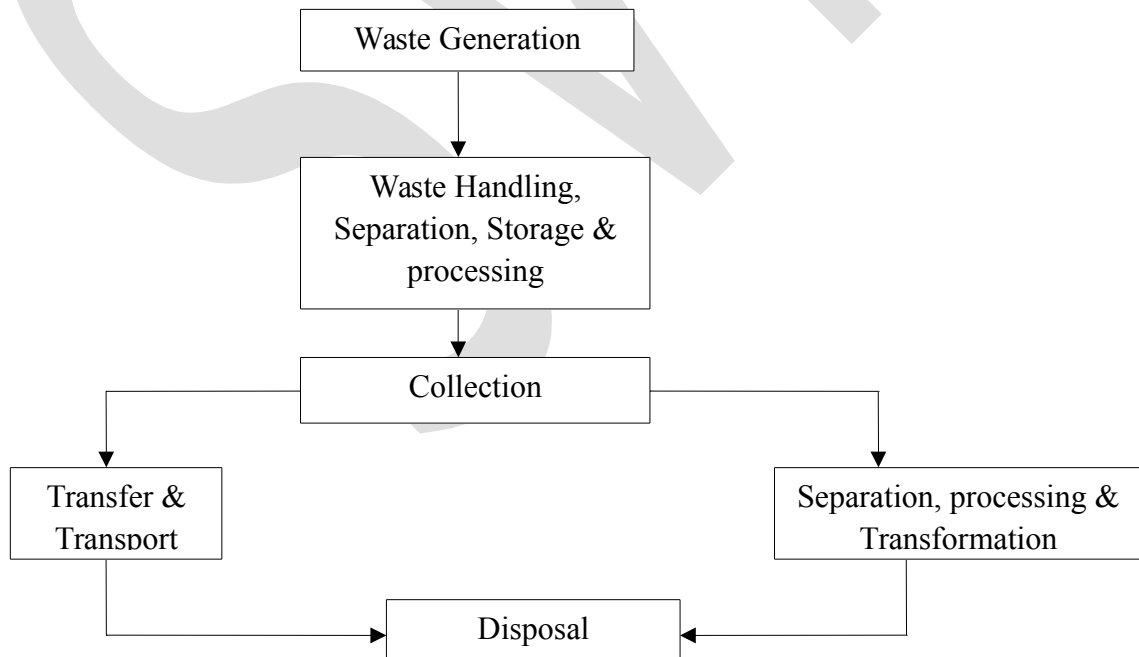

Solid waste Management

i) **Waste generation:** waste generation encompasses activities in which materials are identified as no longer being of value and are either thrown away or gathered together for disposal. Wastes are generated at the start of any process, and thereafter, at every stage as raw materials are converted into goods for consumption. For example, wastes are generated from households, commercial areas, industries, institutions, street cleaning and other municipal services. The most important aspect of this part of the SWM system is the identification of waste.

(ii) **Waste handling, storage, sorting, storage and processing at the source:** Waste handling and sorting involves the activities associated with the management of waste until they are placed in storage for collection.

- Handling also encompasses the movement of loaded container to the point of collection.
- Sorting of waste components is an important step in handling and storage of solid waste at the source. For example, the best place to separate waste materials for reuse and recycling is at the source of generation. Households are becoming more aware of the importance of separating newspaper and cardboard, bottle/glass, kitchen wastes and ferrous and non ferrous materials.
- Onsite storage is of primary importance because of public concerns and aesthetic consideration. Unsightly makeshift containers and even open ground storage, both of which are undesirable, are often seen at residential and commercial sites.
- Processing at the source involves activities such as backyard waste composting.

(iii) **Waste collection:** the functional element of collection includes not only the gathering of solid waste and recycling materials, but also the transport of these materials, after collection, to the location where the collection vehicle is emptied. This location may be materials processing facility, a transfer station or a landfill disposal site.

iv) **Sorting, Processing and transportation of solid waste:** The sorting, processing and transformation of solid waste materials is the fourth of the functional elements. The recovery of sorted materials, processing of solid waste and transformation of solid waste that occurs primarily in the locations away from the source of waste generation are encompassed by this functional element.

- Sorting of mixed waste usually occurs at a material recovery facility, transfer station combustion facilities and disposal sites. Sorting often includes the separation of bulky items, separation of waste components by size using screen, manual separation of waste components and separation of ferrous and non ferrous metals.
- Waste processing is undertaken to recover conversion products and energy.
- The solid waste can be transformed by a variety of biological and thermal process. The most commonly used biological transformation process is aerobic composting. The most commonly used thermal transformation is incineration. Waste transformation is undertaken to reduce the volume, weight, size of waste without resources recovery.

(iv) **Transfer and transport:** This functional element involves:

- The transfer of wastes from smaller collection vehicles to the larger transport equipment.
- The subsequent transport of waste usually over long distances to a processing or disposal site. The transfer usually takes place at a transfer station.

Solid waste Management

(vii) Waste disposal: Today the Disposal of waste by landfilling or uncontrolled dumping is the ultimate fate of all solid wastes, whether they are residential wastes collected and transported directly to a landfill site, residual materials from material recovery facilities, residue from the combustion of solid wastes. Thus, land use planning becomes a primary determinant in the selection, design and operation of landfill operations. A modern sanitary landfill is a method of disposing solid waste without creating a nuisance and hazard to public health.

➤ Classifications of solid waste

Solid wastes are classified into Municipal solid waste, industrial solid waste and Hazardous solid waste.

1. **Municipal solid waste** : includes Municipal solid waste consists of household waste, construction and demolition debris, sanitation residue, and waste from streets. This garbage is generated mainly from residential and commercial complexes. Some of the components of solid wastes are:

- Rubbish: Combustible and non combustible solid waste, excluding food waste or other putrescible materials. Typically combustible waste consist of materials such as paper, cardboard, plastics, textiles, rubber leather, wood and garden trimmings. Non combustible includes items such as glass, crockery, tincans, and aluminum, ferrous and nonferrous metals.
- Ashes and residues – materials remaining from burning of food coke and other combustible wastes. Residues from power plants normally are not included in this category. Ashes and residues are normally composed of fine powdery materials, cinders cum clinkers and small amount of burnt and unburnt materials.
- Construction and demolition waste: Wastes from residential building and other structures are classified as demolition waste. Waste from remodeling and repairing of residential and commercial and industrial building and similar structures are classified as construction waste. These waste includes dirt, stones, concrete, bricks, plasters and plumbing, heating and electrical parts.
- Special wastes : Wastes such as street sweepings, road side litters, catch basin debris, dead animals and abundant vehicles are classified as special waste.
- Treatment plant waste: The solid and semi solid waste water, waste water from industrial areas is included in this classification.

2. **Industrial solid waste** : ISW are those waste arising from industrial activities and typically include rubbish, ashes demolition waste and special waste.

3. **Hazardous waste**: Waste that pose a substantial danger immediately or over a period of time to human, plants are classified as hazardous waste.

A waste is classified as hazardous if it exhibits any of the following characteristics’.

- Ignitibility

Solid waste Management

- Corrosivity
- Reactivity
- Toxicity

In the past , hazardous waste were often grouped into following categories

- Radioactive substances
- Chemicals
- Biological wastes
- Flammable waste
- Explosives

The principal sources of hazardous bio waste are hospitals and biological research institutes. Hazardous waste are generated in limited amounts throughout most of the industrial activities.

General Sources of Municipal Solid waste

Sl. No	Source	Typical facilities, activities or location where wastes are generated	Types of Solid waste
1.	Residential	Single family & multifamily dwellings, low, medium and high rise apartment	Food waste, rubbish, ashes special waste
2.	Commercial	Stores, restaurants, markets, office buildings, hotels, print shops, medical facilities and institutions etc	Food waste, rubbish, ashes, demolition & construction waste, special waste, occasionally hazardous waste
3.	Open areas	Streets, parks, play ground, beaches, highways etc.	Special wastes and rubbish
4.	Treatment plant sites	Water,Waste water from treatment processes etc.	Treatment plant waste principally composed of residual sludge

SALIENT FEATURES OF SOLID WASTE MANAGEMENT RULES 2016

The Government has revamped the Municipal Solid Wastes (Management and Handling) Rules 2000 and notified the new Solid Waste Management Rules, 2016 on April 8, 2016.

The salient features of the SWM Rules, 2016 are as under;

1. Areas Cover:

These rules are applicable to;

Solid waste Management

- Every urban local body (Mega city to Panchayat level),
- outgrowths in urban agglomerations,
- census towns as declared by the Registrar General and Census Commissioner of India,
- notified areas,
- notified industrial townships,
- areas under the control of Indian Railways,
- airports/ airbases,
- Ports and harbors,
- defence establishments,
- special economic zones,
- State and Central government organizations,
- places of pilgrims, religious and historical importance as may be notified by respective State government from time to time and
- every domestic, institutional, commercial and any other non residential solid waste generator situated in the areas.

2. The Waste Generators

- Every household
- Event organizers
- Street Vendors
- RWAs & Market Associations
- Gated Community having area more than 10000 sq.m.
- Hotels & restaurants, etc.

3. Duties of Waste generators and Authorities

- Every Waste Generators shall segregate waste and store separately and hand over to Municipal workers or authorized waste pickers.
- Ministry of Environment, Forest & Climate Change shall constitute 'Central Monitoring Committee' to monitor and review every year.
- MoUD (Ministry of urban Development) shall frame National Policy on SWM and coordinate with States/UTs, provide technical guidelines, financial support, training to local bodies, etc.
- Departments of Fertilizers & Chemicals shall assist in market development for city compost and make available to companies (3/4 bags compost: 6/7 bags Fertilizers).
- Ministry of Agriculture shall make flexible Fertilizer Control Order, promote utilization of compost, testing facility for compost and issue guidelines.
- Ministry of Power shall fix tariff of power generation from W-T-E project and ensure distribution through companies.
- MNRE (Ministry of new & renewable energy) shall facilitate infrastructure for waste-to-Energy plants and provide subsidy.
- Secy- Incharge, UD (state/UT) shall prepare State Policy/Strategy, coordinate for state planning, identification of common/regional landfills, notify guidelines of buffer zones.

Solid waste Management

- District Collector/Magistrate shall facilitate identification of landfill site, quarterly review the performance of local bodies
- Secretary, Panchayats: same as Secy. UD at Panchayat level.
- CPCB shall coordinate with SPCBs/PCCs for monitoring and Annual Reports, formulation of standards, review new technologies, prepare guidelines for buffer zones restricting from residential, commercial and construction activities areas; and inter-state movement of waste.
- Local Authority/Panchayats shall prepare SWM plan with time line and its implementation, segregate, material recovery, processing/ disposal of Waste, user fee and levy spot fine.
- SPCBs/PCCs shall monitor, issue authorization and regulate.
- Manufacturers/Brand owners shall facilitate collect back wastes of their products and provide pouch for packaging sanitary wastes, etc.
- Industry (cement, power plant, etc.) shall use RDF within 100 km.
- Operator of facilities shall follow guidelines/standards

4. Criteria for Hilly Region

Avoid landfill, make waste transfer stations, strict action for littering and construct landfill at plain areas.

5. Waste to Energy plant for waste with 1500 Kcal/kg and above for co-incineration in cement and power plants.

6. Time Frame for Implementation of SWM Rules:

- Landfill Identification : 1 year
- Procurement of waste processing facilities : 2 years
- Ensure segregation of waste : 2 years
- Cities up to 1 million population : 2 Years
- Million plus cities : 3 years
- Setting up sanitary landfills : 3 years
- Bioremediation/capping of old landfills : 5 years

7. Review of implementation of rules at Various levels

- MoEF (Ministry of Environmental & Forest) & CC, Central Monitoring Committee : Every year
- District Collector review performance of Local authorities : Quarterly
- SPCBs (State pollution control board) / PCCs (Pollution control committee) view implementation of Rules with DMA (Directorate of municipal administration) : half yearly
- Secretary Incharge, UD- State level Advisory Committee : half yearly

Properties / composition of Solid waste

Information on properties of solid waste is important in evaluating alternative equipment needs, system and management programmes and plans especially w.r.t to implementation of disposal and resource and energy recovery operations.

Solid waste Management

I. Physical Composition or Properties

- Specific Weight (Density)
- Moisture Content
- Particle Size and Distribution
- Field Capacity
- Permeability of Compacted Waste

1. Specific Weight (Density):

- Specific weight is defined as the weight of a material per unit volume (e.g. kg/m³, lb/ft³).
- Usually it refers to uncompacted waste.
- It varies with geographic location, season of the year, and length of time in storage.

Typical Specific Weight Values

Components	Density (kg/m ³)	
	Range	Typical
Food wastes	130-480	290
Paper	40-130	89
Plastics	40-130	64
Yard Wastes	65-225	100
Glass	160-480	194
Tin cans	50-160	89
Aluminum	65-240	160

2. Moisture Content:

The moisture content of solid waste usually expressed as the mass of moisture per unit mass of wet or dry materials. In the wet mass method of measurement, the moisture in a sample is expressed as a percentage of the wet mass of the material. In dry mass method, it is expressed as a percentage of the dry mass of the materials

The wet mass Moisture content is expressed as follows

$$\text{Moisture Content} = \frac{a-b}{a} \times 100$$

Where a = Initial mass of sample

b = mass of sample after drying

To obtain the dry mass, the solid waste material is dried in an oven at 77°C for 24hrs. This temperature and time used to dehydrate the materials completely and to limit the vaporization of volatile materials.

3. Particle Size and Distribution

Solid waste Management

The size and distribution of the components of wastes are important for the recovery of materials, especially when mechanical means are used, such as trommel screens and magnetic separators.

The size of waste components can be determined using the following equations:

- $Sc = L$
- $Sc = (L+w)/2$
- $Sc = (L+w+h)/3$

Where Sc : size of component, mm

L : length, mm

W : width, mm

h : height, mm

4. Field Capacity

The total amount of moisture that can be retained in a waste sample subject to the downward pull of gravity.

Field capacity is critically important in determining the formation of leachate in landfills.

It varies with the degree of applied pressure and the state of decomposition of wastes, but typical values for uncompacted commingled wastes from residential and commercial sources are in the range of 50-60%.

5. Permeability of Compacted Waste

The permeability (hydraulic conductivity) of compacted solid waste is an important physical property because it governs the movement of liquids & gases in a landfill.

Permeability depends on: • Pore size distribution • Surface area • Porosity

I. Chemical Composition

- Chemical properties of MSW are very important in evaluating the alternative processing and recovery options.
- Used primarily for combustion and waste to energy (WTE) calculations but can also be used to estimate biological and chemical behaviours.
- Waste consists of combustible (i.e. paper) and non-combustible materials (i.e. glass).

If solid wastes are to be used as fuel, the four most important properties to be known are:

Chemical Composition or Properties

- 1 Proximate Analysis
 - Moisture
 - Volatile Matter
 - Ash
 - Fixed Carbon
- 2 Fusing Point of Ash

- 3 Ultimate Analysis (% C, H, O, N,S & Ash)
- 4 Heating Value (Energy Value)

1. Proximate Analysis

- Loss of moisture (temp held at 105°C)
- Volatile Combustible Matter (VCM) (temp increased to 950°C, closed crucible)
- Fixed Carbon (residue from VCM)
- Ash (temp = 950°C, open crucible)

2. Fusing Point of Ash

Clinker (agglomerations of carbon and metals) formation at a temperature 1100-1200°C.

3. Ultimate Analysis

Analysis has been made to determine the percentage of carbon, hydrogen, oxygen, sulphur and ash in solid waste.

Molecular composition (C, H, N, O, P, etc.)

4. Energy Content

Knowledge of the energy content of an organic fraction of solid waste is essential for evaluating its potential for use as a fuel in a combustion system.

- Depends on the constituents of a sample
- Can be estimated by modified Dulong formula

Energy Content (KJ/Kg) = $338.2C + 1430(H - O/8) + 95.4S$

: Energy values may be converted to a dry basis by the following equation

$$\text{Kj/kg (Dry basis)} = \frac{100}{100 - \text{moisture}}$$

The corresponding equation on ash free dry basis is

$$\text{Kj/kg (ash free dry basis)} = \frac{100}{100 - \%ash - \text{moisture}}$$

Factors affecting Waste generation rate

- **Source Reduction & Recycling Activities**
- **Public Attitudes and Legislation**
- **Geographic location and physical factors on generation of Solid waste**

1. Source Reduction & Recycling Activities

Solid waste Management

Waste reduction may occur through the design, manufacture and packing of products with the minimum toxic content, minimum volume of materials and with minimum materials of longer useful life.

- Waste reduction may also occur at the household, commercial or industrial facility through selective buying patterns and by the use of recyclable materials.
- Source reduction is not considered an important element at the present time, because it is difficult to estimate the impact of reduction on the total quantity of waste generated. Never the less, source reduction will likely become an important factor in reducing the quantity of waste generated.

Some of the other ways in which source reduction can be achieved can be follows

- a) Use fewer resources
- b) Develop rate structures that encourages to produce less waste
- c) Decrease unnecessary and excessive packing materials
- d) Substitute recyclable products for disposal

2. Public Attitudes and Legislation

Public attitudes: Ultimately significant reduction in the quantity of waste generated when and only if people are willing to change their habits, lifestyle and to reduce burden associated with management of solid waste. A program of continuing education is essential to bring about change in the public attitude.

notes4free.in

Legislation: The most important factors affecting the generation of certain type of waste is the existence of local, state and regulation concerning the use of specific materials. Legislation dealing with packing of products is an example.

3. Geographic location and physical factors on generation of Solid waste

Geographic location and physical factors that affect the quantities of waste generation and collection include location season of the year, waste collection frequency and characteristics of the service area.

Geographic location – The influence of geographic location, different climates that influences both the amount of certain types of solid waste generated and the time period over which waste is generated. For example substantial variation in the amount of yard and garden waste generated in various parts of the country are related to climates. That is in warmer southern areas, where the growing season is longer than northern areas, yard wastes are collected not in considerable amounts but also over longer time.

Season of the year: The quantity of certain type of waste are also affected by the season of the year.

Collection of Solid Waste

Solid waste Management

Collection of separated or unseparated solid waste in urban areas is difficult and complex because of the generation of residential, commercial or industrial solid waste takes place in every home, apartment, commercial or industrial facility, streets, parks and even in vacant areas.

❖ Types of Collection Service

The Various types of collection service are

1. Municipal Collection service / Residential collection service
 - A. From low rise detached dwellings
 - B. From low and medium rise apartment
 - C. From high rise apartment
2. Commercial and Industrial collection service

a. Municipal Collection service / Residential collection service

Collection service varies depending upon the type of dwelling unit, collection for low rise detached dwellings and collection for medium and high rise apartments are considered separately.

The most common types of residential services in various parts of the country include

1. Curb
2. Alley
3. Set out – Set back
4. Set out
5. Backyard carrying

notes4free.in

1. **Curb** – is used for low rise detached dwelling. This is a manual type of collection system where in the waste are collected in a curb on a collection day and the containers are returned back to their storage location until the next collection.
2. **Alley** - are part of the basic layout of a city or a given residential area. Alleys are storage of container used for solid waste collection.
3. **Set out – Set back** – Containers are set out from the owners property and set back after being emptied by additional crew.
4. **Set out** – this service is essentially the same as set-out & set-back, except that the home owner is responsible for returning the container back their storage location.
5. **Backyard Carrying** – The collection crew is responsible for entering the owners property and removing the waste from their storage location.

2. Commercial and Industrial collection service

- Both manual and mechanical means are used to collect waste from commercial and industrial areas. To avoid traffic congestion during the day time, solid waste from commercial establishment in many cities are collected in the late evening and early morning.
- Where manual collection is used, Wastes are put in plastic bags, cardboard boxes and other disposable containers that are placed at curbs for collection.

Solid waste Management

- The Collection services provided to large apartment buildings, residential complexes, commercial and industrial areas are provided to these centers on the use of movable containers, stationery containers, and large stationery compactors.
- Compactors are of the type that can be used to compress materials into large containers.

❖ Types of Collection Systems

Based on the mode of operation, collection systems are classified in to two categories:

1. Hauled container systems
2. Stationery container systems

1. Hauled Container system: Drive to next loaded container

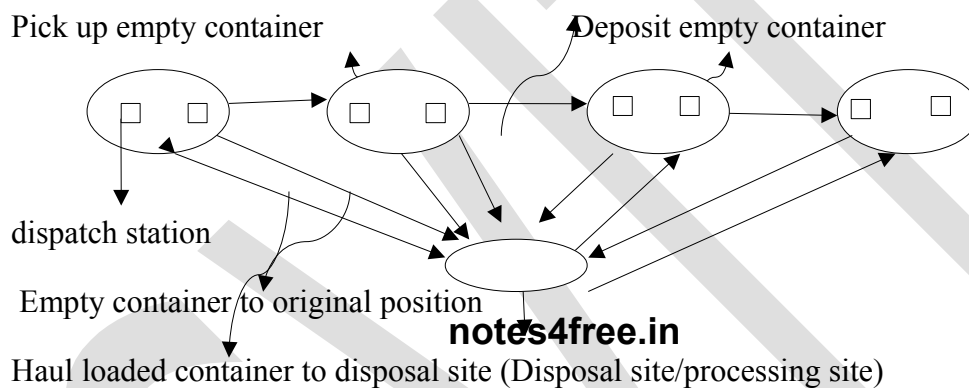

Collection system in which the containers used for the storage of waste are hauled to the processing, transfer or disposal site, emptied and returned to either their original location or some other location are defined as hauled container system. The collector is responsible for driving the vehicle, loading the containers and emptying the contents of containers at disposal site.

There are two main types of hauled container systems

1. Tilt Frame container
2. Trash-trailors

Systems that use tilt frame loaded vehicles often called drop boxes are ideally suited for collection of all types of solid waste and rubbish from locations where generation rates warrants the use of large containers. Because of large volume that can be hauled, the use of tilt frame hauled container systems has become widespread, especially among private services.

Trash trailers are better for collection of especially heavy rubbish such as sand, timber and metal scrap and often are used for collection of demolition waste at construction sites.

Advantages

1. Hauled container systems are flexible containers of many different shapes and sizes are available for collection of all types of wastes.

Disadvantages

1. Because the container used in this system must be filled, usually the use of very large containers often lead to low volume utilization.
2. Through this system requires only one truck and driver to accomplish the collection cycle, each container picked up requires a round trip to disposal site.

2. Stationery Collection system

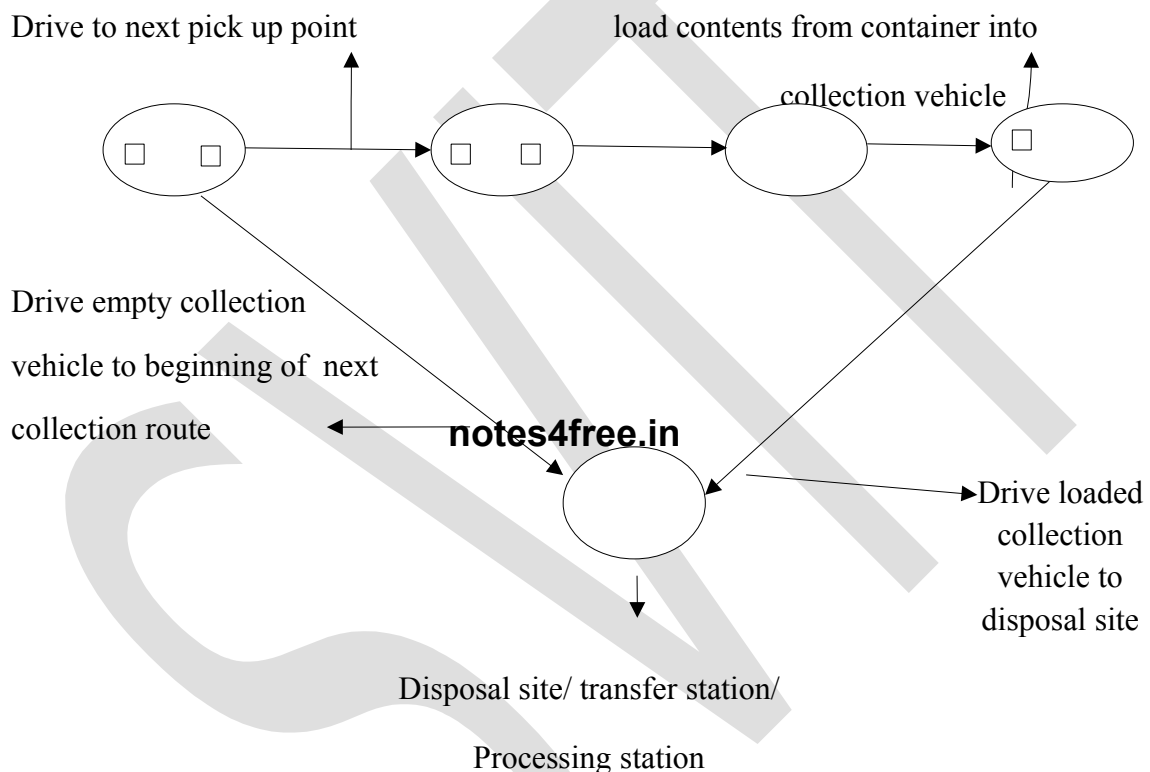

Collection system in which the container used for the storage of waste remains at the point of waste generation, except when moved for collection are defined as stationery container system.

There are two main types of stationery container systems

1. Those in which self loading compactors used
2. Those in which manually loaded vehicles are used.

Trips to the disposal site, transfer station, or processing station are made after the contents of a no of containers have been collected and compacted and collection vehicle is full. Because a variety of container sizes and types are available, these systems may be used for collection of all types of wastes.

Solid waste Management

❖ Transfer Means and Methods (Transport Methods)

Motor vehicles, rail road's and ocean going vessels are the principle means used to transport waste. Pneumatic and hydraulic systems have also been used.

1. Motor Vehicle Transport - Motor vehicles used to transport solid wastes on highway should satisfy the following requirement.

- The vehicles must transport wastes at minimum costs
- Wastes must be covered during haul operation
- Vehicles must be designed for highway traffic
- Vehicle capacity must be such that allowable weight limits are not exceeded
- Methods used for unloading must be simple and dependable.

In the recent years because of their simplicity and dependability, open top trailers and semitrailers have found wide acceptance for the transport of waste. Some trailers are equipped with sumps to collect any liquid that accumulate from the solid waste.

2. Rail Road Transport - Although Rail road's were commonly used for the transport of solid waste in the past, they are now used by a few communities. However renewed interest is again developing in the use of rail road for hauling solid waste especially to remote areas where highway travel is difficult and rail lines now exist.

3. Water Transport – Barges, scows and special boats have been used in the past to transport solid wastes to processing location and to seashores and ocean disposal sites, but ocean disposal is no longer practiced by developing countries.

4. Pneumatic Transport – Both low pressure air and vacuum conduit transport systems are used to transport solid waste.

- The most common application is the transport of waste from high density apartment or commercial activities to central location for processing or for loading into transport vehicles.

Transfer Station

Important factors that must be considered in the design of transfer station include:

1. Type of transfer operation
2. Capacity Requirement
3. Equipment and accessory requirement
4. Environmental requirement

1. Type of transfer operation : Depending on the method to load the transport vehicles, transfer stations may be classified into three types:

- A. Direct Discharge
- B. Storage Discharge

Solid waste Management

C. Combined direct and storage discharge.

A. Direct discharge – In a direct discharge transfer station, wastes from the collection vehicles usually are emptied directly into the vehicle to be used to transport them to a place of final disposal.

- To accomplish this, these stations are constructed in a two level arrangement. The unloading platform from which the wastes from collection vehicles are discharged into the transport trailers are elevated. Direct discharge transfer stations employing stationery compactors are popular.

B. Storage discharge – In this transfer station, wastes are emptied either into a storage pit or onto a platform from which they are loaded into transfer vehicles by various types of auxiliary equipment.

- In a storage discharge transfer station, the various processing techniques like shredding, separation, magnetic separation of ferrous scraps, compaction are employed by using various types of auxiliary equipment.

C. Combined direct and storage discharge – In some transfer station, both the methods are used. Usually these are multipurpose facilities designed to service a broader range of users than a single purpose facility.

2. Capacity Requirement – The operational capacity of a transfer station must be such that the collection vehicles do not have to wait too long to unload.

- In most cases it will not be cost effective to design the station to handle the ultimate peak no of hourly loads. An economic analysis should be made between the annual cost for the time spent by the collection vehicle waiting to unload against the incremental annual cost of a transfer station or the use of more transport equipment.
- Because of the increased cost of transport equipment, trade off analysis must also be made between the capacity of transfer station and the cost of the transport operation including both equipment and labor components.

3. Equipment and Accessory Requirements - The types and amounts of equipment required vary with the capacity of a station and its function in the waste management system.

- Specifically scales should be provided at all medium and large transfer station both to monitor the operation and to develop meaningful management and engineering data.

4. Environmental Requirements – Most of the large transfer stations are enclosed and are constructed of materials that can be maintained and cleaned easily.

Solid waste Management

- For direct discharge transfer stations with open loading areas, special attention must be given to the problem of blowing papers. Wind screens or other barriers are to be used.
- Regardless of the type of transfer station, the design and construction should be such that all accessible areas where rubbish or paper can accumulate or eliminated.

❖ Factors affecting the location of transfer station

Whenever possible, transfer station should be located

1. As near as possible, the weighted center of the individual solid waste production areas to be served
2. Within easy access of major arterial highway routes as well as near secondary or supplemental means of transportation.
3. Where there will be minimum public and environmental objections to the transfer operations.
4. Where construction and operation will be economical
5. Additionally if the transfer station site is to be used for processing techniques involving materials recovery and energy production, the requirement for those operation must be considered.

❖ Route Optimization

Once the equipment and labor requirements are determined, collection routes must be laid out so both the collectors and equipments are used effectively. In general the layout of collection route involves a series of trial. There is no universal set of route that can be applied for all the situations.

Some guidelines that should be taken into consideration when laying out routes are as follows.

1. Existing policies and regulation related to such items as the point of collection and frequency of collection must be identified.
2. Existing system characteristics such as crew, size and vehicle type must be coordinated.
3. Whenever possible route should be laid down so that they begin and end near arterial roads using topographical and physical barriers as route boundaries.
4. In hilly areas, route should start at the top of the grade and proceed downhill as the vehicle is loaded.
5. Routes should be laid out so that the last container to be collected on the route B located nearest to the disposal site.
6. Waste generated at traffic congested location should be collected as early as possible.
7. Sources at which extremely large quantities should be serviced during the first part of the day.

Solid waste Management

8. Scattered pick up points where small quantities of solid waste generation that receive the same collection frequency should if possible be serviced during one trip or on the same day.

notes4free.in

MODULE – 2

Processing Techniques

Processing techniques is used in solid waste management.

The purposes of processing essentially are

1. Improving efficiency of SWM system:
 - Various processing techniques are available to improve the efficiency of SWM system.
 - For example, before waste papers are reused, they are usually baled to reduce transporting and storage volume requirements.
 - In some cases, wastes are baled to reduce the haul costs at disposal site where solid wastes are compacted to use the available land effectively.
2. Recovering material for reuse:

Materials that have a market, when present in wastes in sufficient quantity can be recovered from solid wastes include paper, cardboard, plastic, glass, ferrous metal, aluminum and other residual metals.
3. Recovering conversion products and energy:

Combustible organic materials can be converted to intermediate products and ultimately to usable energy. This can be done either through incineration, pyrolysis, composting or biogas production.

Initially, the combustible organic matter is separated from the other solid waste components.

Once separated, further processing like shredding and drying is necessary before the waste material can be used for power generation.

Processes used routinely to improve the efficiency of solid waste systems and to recover materials are

1. Mechanical Volume Reduction (Compaction)
2. Chemical Volume Reduction (Incineration)
3. Mechanical size reduction (Shredding)
4. Component Separation (Manual or Mechanical)

1. Mechanical Volume Reduction (Compaction)

Mechanical volume reduction is perhaps the most important factor in the development & operation of solid waste management systems. Volume reduction is nothing but the reduction of initial volume of waste by the application of force or pressure. In most cases vehicles equipped with compaction mechanism are used for the compaction of the waste.

Some of the benefits of compaction include:

- To increase the useful life of landfills, wastes are compacted.
- reduction in the quantity of materials to be handled at the disposal site;
- improved efficiency of collection and disposal of wastes

Disadvantages associated with compaction:

- Poor quality of recyclable materials sorted out of compaction vehicle.
- Difficulty in segregation or sorting (since the various recyclable materials are mixed and compressed in lumps)
- Bio-degradable materials (e.g., leftover food, fruits and vegetables) destroy the value of paper and plastic material.

Paper, cardboard, plastic, aluminum, tin cans are removed from solid waste for recycling and baled to reduce the storage, handling and shipping costs.

notes4free.in

Equipment used for compaction based on their mobility

Stationary equipment

Movable equipment

1. **Stationary equipment:** Equipment in which wastes are brought to and loaded into either manually or mechanically. The compaction mechanism used to compress waste in a collection vehicle, is a stationary compactor.
 - According to their application, stationary compactors can be described as light duty (e.g., those used for residential areas), commercial or light industrial, heavy industrial and transfer station compactors.
 - Large stationary compactors are necessary, when wastes are to be compressed into:
Steel containers that can be subsequently moved manually or mechanically;
Chambers where they are compressed into a block and then released and hauled away untied; transport vehicles directly.
2. **Movable equipment:** This represents the wheeled and tracked equipment used to place and compact solid wastes as in a sanitary landfill.

According to their compaction pressure, we can divide the compactors used at transfer stations as follows:

High pressure compaction — recently a number of high pressure compaction systems have been developed.

- In most of these systems specialized compaction equipment is used to produce compressed solid waste blocks or bales of various sizes.
- In one system the size of the completed block is about 4inc*4inc*16inch.
- In other system pulverized wastes are extracted after compaction in the form of logs approximately 9inch diameter.
- The Volume reduction achieved with this high pressure compaction system varies with the characteristics of waste.

Low Pressure compaction — typically low pressure compactors include those used at apartments and commercial establishment.

- Baling equipment's is used for waste papers, cardboard while stationary compactors are used at transfer station.
- Portable stationary compactors are used increasingly by no of industries with material recovery operation.

2. Mechanical size Reduction (Shredding)

This is required to convert large sized wastes (as they are collected) into smaller pieces. Size reduction helps in obtaining the final product in a reasonably uniform and considerably reduced size in comparison to the original form.

- The objective of size reduction is to get a final product that is reasonably uniform and considerably reduced when compared to its original form. In some situations the total volume of the materials after size reduction may be greater than that of original volume.

Size Reduction Equipment

The types of equipment that can be used for reducing the size of homogenous solid waste includes small grinder, chippers, big grinder, jaw crushers, hammer mills, shredders etc..

Types, mode of action and applications of equipment's used for mechanical size reduction.

SOLID WASTE MANAGEMENT

1	Small Grinder	Grinding, mashing	Organic residential solid waste
2	Chipper	Cutting & slicing	Paper, cardboard, tree trimming & plastic
3	Large grinder	Grinding, mashing	Brittle materials ,used mostly in inorganic operations
4	Jaw Crusher	Crushing & breaking	Large solids
5	Rasp mills	Shredding & tearing	Moistened solid waste most commonly used in municipal solid waste.
6	Cutters, clippers	Shredding & tearing	All types of municipal waste
7	Hammer mill	Breaking, tearing, cutting, crushing	All types of municipal waste, most common equipment for reducing size and homogenizing solid waste.
8	Hydropulper	Shearing, tearing	Ideally suited for use with pulpable waste like paper, wood chips etc used primarily in the paper industry.

The most frequently used shredding equipment are the following:

notes4free.in

(i) Hammer mill:

- These are used most often in large commercial operations for reducing the size of wastes.
- Hammer mill is an impact device consisting of a number of hammers, fastened flexibly to an inner disk which rotates at a very high speed.
- Solid wastes, as they enter the mill, are hit by sufficient force, which crush or tear them with a velocity so that they do not adhere to the hammers.
- Wastes are further reduced in size by being struck between breaker plates and/or cutting bars fixed around the periphery of the inner chamber.
- This process of cutting and striking action continues, until the required size of material is achieved and after that it falls out of the bottom of the mill.

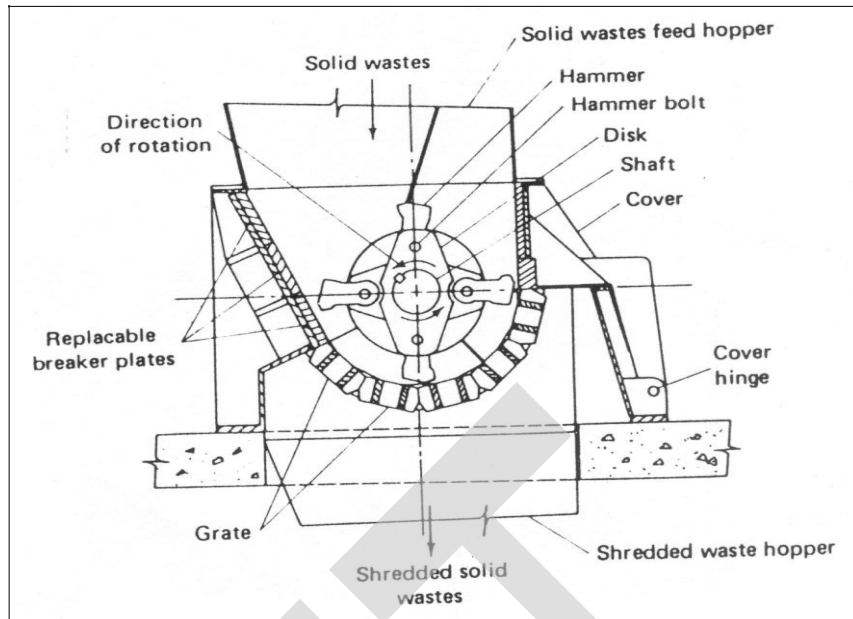

ii. Hydro pulper

- An alternative method of size reduction involves the use of a hydropulper
- Solid wastes and recycled water are added to the hydropulper. The high speed cutting blades, mounted on a rotor in the bottom of the unit, convert pulp able and friable materials into slurry with a solid content varying from 2.5 to 3.5%.
- Metal, tins, cans and other non-pulp able or non-friable materials are rejected from the side of the hydropulper tank.
- The rejected material passes down a chute that is connected to a bucket elevator, while the solid slurry passes out through the bottom of the pulper tank and is pumped to the next processing operation.

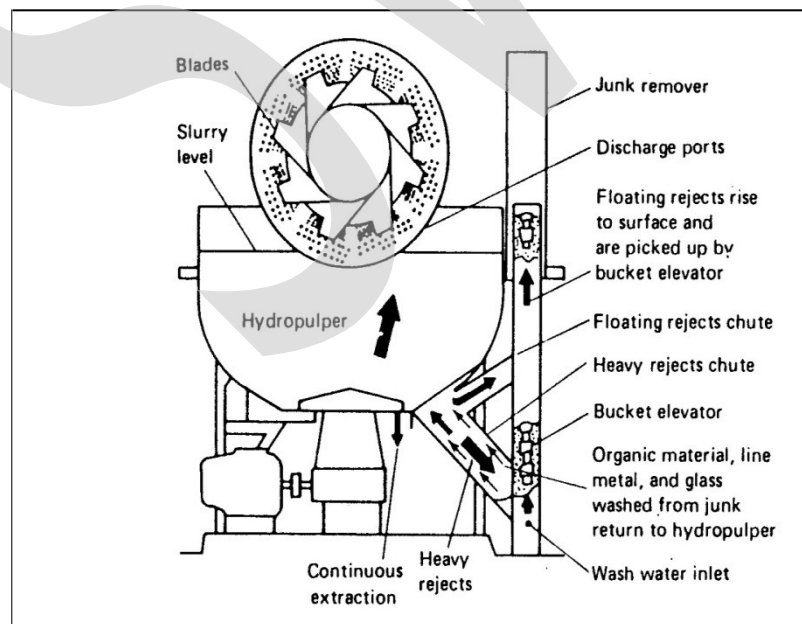

3. Component Separation

It is necessary operation in the recovery of resources from solid waste and where energy and conversion product are to be recovered from processed waste. The required separation may be accomplished manually or mechanically. When manual separation is used preprocessing of waste is not required in most techniques, however some form of size reduction is required as a first step.

A. Air separation

- This technique has been in use for a number of years in industrial operations for segregating various components from dry mixture.
- Air separation is primarily used to separate lighter materials (usually organic) from heavier (usually inorganic) ones.
- The lighter material may include plastics, paper and paper products and other organic materials. Generally, there is also a need to separate the light fraction of organic material from the conveying air streams, which is usually done in a cyclone separator. In this technique, the heavy fraction is removed from the air classifier (i.e., equipment used for air separation) to the recycling stage or to land disposal, as appropriate.
- The light fraction may be used, with or without further size reduction, as fuel for incinerators or as compost material. There are various types of air classifiers commonly used, some of which are listed below:

1. Conventional chute type

- In this type, when the processed solid wastes are dropped into the vertical chute, the lighter material is carried by the upward flow to the top while the heavier materials fall to the bottom of the chute.
- The control of the percentage split between the light and heavy fraction is accomplished by varying the waste loading rate, airflow rate and the cross section of chute.
- A rotary air lock feed mechanism is required to introduce the shredded wastes into the classifier.

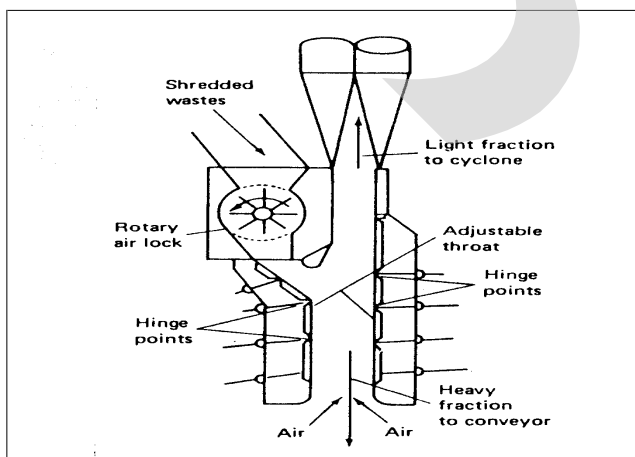

2. Zigzag air classifier

- Shredded wastes are introduced at the top of the column at a controlled rate, and air is introduced at the bottom of the column.
- As the wastes drop into the air stream, the lighter fraction is fluidized and moves upward and out of column, while the heavy fraction falls to the bottom.
- Best separation can be achieved through proper design of the separation chamber, airflow rate and influent feed rate.

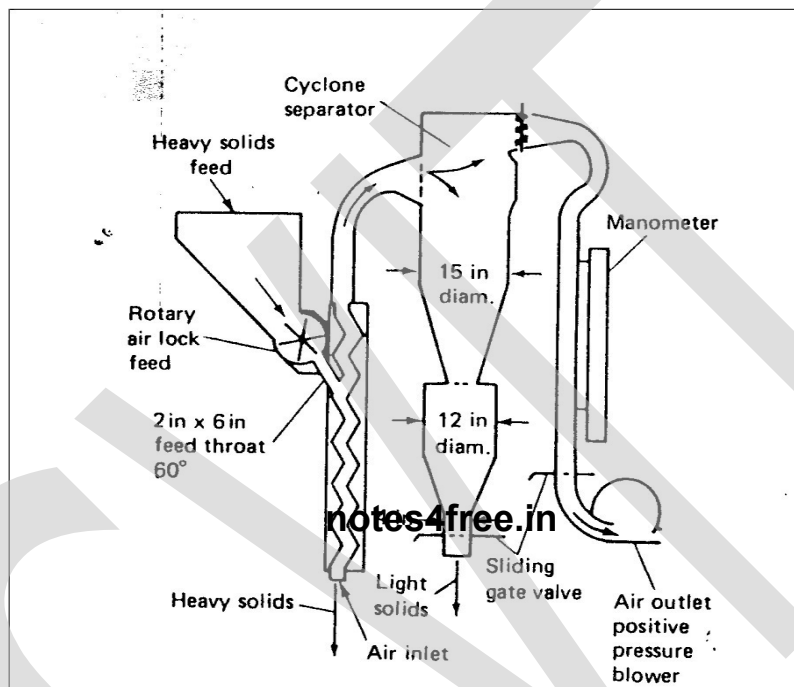

B. Magnetic separation

The most common method of recovering ferrous scrap from shredded solid wastes involves the use of magnetic recovery systems.

- Ferrous materials are usually recovered either after shredding or before air classification. When wastes are mass-fired in incinerators, the magnetic separator is used to remove the ferrous material from the incinerator residue. Magnetic recovery systems have also been used at landfill disposal sites.
- The specific locations, where ferrous materials are recovered will depend on the objectives to be achieved, such as reduction of wear and tear on processing and separation equipment, degree of product purity achieved and the required recovery efficiency.

Equipment used for magnetic separation

SOLID WASTE MANAGEMENT

Various types of equipment are in use for the magnetic separation of ferrous materials. The most common types are the following:

- a) **Suspended magnet:** In this type of separator, a permanent magnet is used to attract the ferrous metal from the waste stream. When the attracted metal reaches the area, where there is no magnetism, it falls away freely. This ferrous metal is then collected in a container. This type of separation device is suitable for processing raw refuse, where separators can remove large pieces of ferrous metal easily from the waste stream.

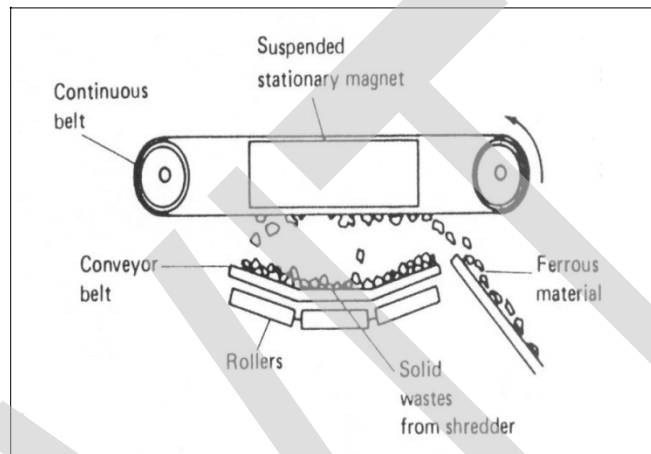

notes4free.in

- b) **Magnetic pulley:** This consists of a drum type device containing permanent magnets or electromagnets over which a conveyor or a similar transfer mechanism carries the waste stream. The conveyor belt conforms to the rounded shape of the magnetic drum and the magnetic force pulls the ferrous material away from the falling stream of solid waste.

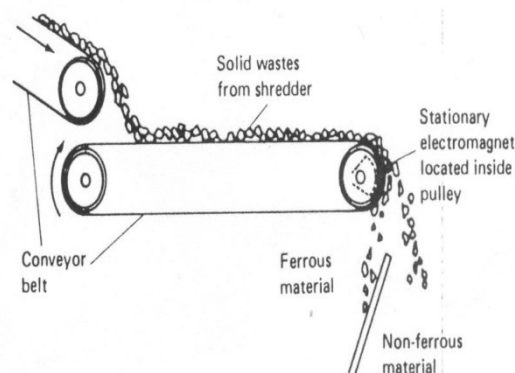

C. Screening

Screening is the most common form of separating solid wastes, depending on their size by the use of one or more screening surfaces.

- Screening has a number of applications in solid waste resource and energy recovery systems. Screens can be used before or after shredding and after air separation of wastes in various applications dealing with both light and heavy fraction materials.
- The most commonly used screens are rotary drum screens and various forms of vibrating screens.
- Note that rotating wire screens with relatively large openings are used for separation of cardboard and paper products, while vibrating screens and rotating drum screens are typically used for the removal of glass and related materials from the shredded solid wastes.

D. Heavy Media Separation — Although the removal of aluminum can be accomplished in a number of different ways. Heavy media separation is the best process for which the, greatest operating experience exists principally in the automobile recovery industry.

- In this process the feedstock i.e. rich in aluminum such as air classified solid waste where in ferrous metals and glass has been removed, is dumped into a liquid which has a high specific gravity. notes4free.in
- The specific gravity is maintained at higher level that will permit aluminum to float and other materials remain submerged.
- At present the major disadvantage of this process is that the optimum size plant requires about 2000 — 3000 tons per day of feed stock

E. Optical sorting - Optical sorting is used mostly to separate glass from the waste stream, and this can be accomplished by identification of the transparent properties of glass to sort it from opaque materials (e.g., stones, ceramics, bottle caps, corks, etc.) in the waste stream.

- Optical sorting involves a compressed air blast that removes or separates the glasses – plain or coloured.
- An optical sorting machinery is, however, complex and expensive

F. Hand Sorting- The manual separation of solid waste components are accomplished at a source where solid waste is generated or at the disposal site.

- The number and types of components sorted depend on the location and the resale market.
- Typically the components include newspaper, aluminum, and glass from residential sources, cardboard, & high quality paper, metals, wood from

commercial & industrial source, metals, wood & bulky items of value from transfer station & disposal site.

- Previewing of the waste stream and manual removal of large sized materials is necessary, prior to most types of separation or size reduction techniques.
- This is done to prevent damage or stoppage of equipment such as shredders or screens, due to items such as rugs, pillows, mattresses, large metallic or plastic objects, wood or other construction materials, paint cans, etc.

G. Electro Static Separation - High voltage electro static fields can be used to separate glass from the heavy fraction of air classified waste.

A vibrating feeder feeds waste to a negatively charged rotating drum. Positive electrode near the drum and the feeder induces a charge in the waste particles.

Nonconductors such as glass and clay retain the charge where as crystalline materials such as rock loose it rapidly.

The drum holds nonconductor and the remaining materials drops off.

notes4free.in

CHEMICAL VOLUME REDUCTION (INCINERATION)

Incineration can be defined as the controlled combustion process for burning of solid, liquid waste to residue containing non-combustible materials.

Incineration is one of the chemical process used to reduce the volume of the solid waste. This process is also called as chemical volume reduction.

Incineration is a chemical reaction in which carbon, hydrogen and other elements in the waste mix with oxygen in the combustion zone and generates heat.

At present it is one of the common method used to reduce the volume of waste chemically, chemical process such as pyrolysis, hydrolysis and chemical conversion are also effective in reducing the volume of waste.

Normally all the combustible matters such as garbage rubbish and dead animals are burnt and the incombustible matters like chinaware, glass, metals etc. are left unburnt or separated out for recycling and reuse before the burning of solid wastes.

The air requirements for combustion of solid wastes are considerable. For example, approximately 5000 kg of air is required for each ton of solid wastes burned. Usually, excess air is supplied to the incinerator to ensure complete mixing and combustion and to regulate operating temperature and control emissions. Excess air requirements, however, differ with moisture content of waste, heating values and the type of combustion technology employed. The principal gas products of combustion are carbon dioxide, carbon monoxide, water, oxygen and oxides of nitrogen.

Many incinerators are designed to operate in the combustion zone of 900°C – 1100°C. This temperature is selected to ensure good combustion, complete elimination of odors and protection of the walls of the incinerator. Incinerator systems are designed to maximize waste burn out and heat output, while minimizing emissions by balancing the oxygen (air) and the three “Ts”, i.e., time, temperature and turbulence. Complete incineration of solid wastes produces virtually an inert residue, which constitutes about 10% of the initial weight and perhaps a larger reduction in volume. The residue is generally landfilled.

Advantages of Incineration

- It is the only practical method of disposing of certain wastes such as unwanted chemicals and contaminated material which cannot go to landfill. If incineration is not available locally such material has to be exported.
- Significantly reduces the quantity of material that must go to landfill and associated pollution risks.
- Produces useful energy from waste, reducing fossil fuel consumption and resulting greenhouse gas (GHG) emission.
- The costs, energy usage and GHG emissions can be lower than those in the collection, transport and processing involved in recycling.
- Building incinerators in or close to urban areas reduces the cost of and emissions from waste transport and means the waste is treated where it is generated.

Disadvantages of Incineration

- If incorrectly operated can lead to the release of harmful levels of pollutants. Even in proper operation small amounts of fine particles and pollutants are released. As the technology has matured emission levels have reduced dramatically – in Germany in 2000 dioxin emissions were ~1/1000th of the 1990 levels.
- Incineration of MSW produces relatively large amounts of fly ash (approximately 4% of original waste weight) which must be dumped in secure landfills.

- Incineration could reduce the incentive to recycle. The energy content of waste with all recyclable components removed is much less than unsegregated waste. Incineration plants could compete with recycling for some materials.
- Incineration plants have a large initial capital cost and require long term contracts to be viable. This could hamper the deployment of future more efficient waste treatment technology.

3T'S of Incineration process

- **Time**
- **Temperature**
- **Turbulence**

Time: some wastes are exposed for sufficient time to atmosphere for complete combustion. Sufficient residence time must be allowed to achieve efficiency as well as to assure conversion of products of incomplete combustion to desirable incinerator product.

Temperature: In any combustion process the temperature is the most significant factor in ensuring proper *disposal* of the hazardous waste.

- The temperature that will ensure the destruction of waste & at the same time will allow for cost effective operation.
- The temperature for incineration process varies from 550 1000°C. Temperature range is controlled to be above 750°C to ensure adequate combustion and below 1000°C to prevent ash melting and clogging the grate.
- The temperature is controlled by the addition of diluted air to the furnace as required.

Turbulence- Turbulence ensure the mixing of each volume of gas with sufficient air for complete burning of combustible matter and suspended particulates. The degree of turbulence may be used effectively to attain desirable efficiency and decrease the operating temperature and time requirement.

AIR POLLUTION CONTROL EQUIPMENTS

Fabric Filters

Electrostatic Precipitator

Fabric Filters

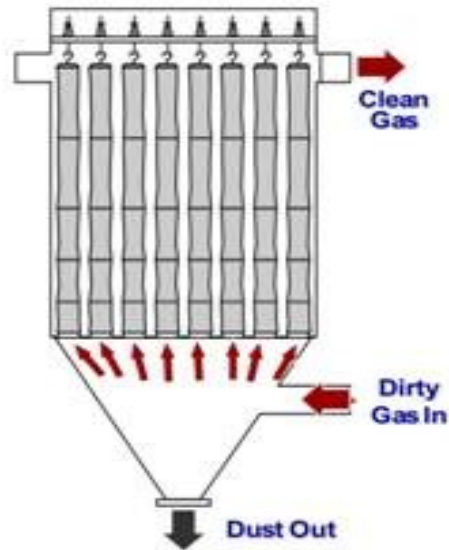

Filtration is one of the most reliable, efficient & economic method by which the particulate matter can be removed. from the gas.

- The most common type of fabric collector is the tabular type consisting of tabular bags or bag filter.
- A no of filter bags are connected in parallel in housing.
- The gas entering through the inlet pipe strikes a baffle wall which causes the large particles to fall into a hooper due to gravity.
- The carrier as then flows upward into the tube and then outward through the fabric leaving the particulate matter inside the bags.
- The dust becomes the actual filtering medium. The bags in effect act primarily as a matrix to support the dust.
- Filter bags can be cleaned by shaking or vibration or by reverse air flow causing the filter to be loosened and to fall into the hopper below.

Advantages

- High collection efficiencies for all particle size.
- Simple construction & operation.
- Normal power usage
- Dry disposal of collected material.

Disadvantages

- Large size of equipment.
- Problems in handling dust which may corrode the filter cloth.
- High maintenance & fabric replacement cost.
 - Temperature of flue gas has to be cooled to a temperature of 100 — 400°c, so that the fabric filters are stable.

Electrostatic Precipitator [ESP]

The electrostatic precipitator was the first particle control device used for MSW combustor that was capable of removing fine particle of size lesser than 10 μ m upto an extent of 0.1 μ m.

- They operate on principle of electrostatic attraction.
- In electrostatic precipitators, the gas stream is passed between two electrodes, across which the high potential difference is maintained. Out of that one is collecting electrode and other one is discharging electrode.
- Because of high potential difference and discharge system, a powerful ionizing field is formed. Potentials as high as 100KV are used.
- As the particulates in the carrier gas pass through this field, they get charged and migrate the oppositely charged collecting electrode.
- The particles once deposited on the collecting electrode, lose their charge and are removed by vibration to a hopper below.

Thus, the four steps in this process are

- Particulate matters are charged.
- The particles migrate to the collector
- Neutralize the charge at the collector
- Remove the collected particles

Advantages

- High collection efficiency.
- Low maintains & operation cost
- Treatment time is negligible.
- Cleaning is easy by removing units, in the precipitators.
- Particles are as small as 0.1 μ m can be removed.

Disadvantages

- Initial cost is high.
- Space requirement is more because of large size equipment.
- Possible explosion hazards during collection of combustible gases.
- Precautions are necessary to maintain for safety during operation. Proper gas flow distribution, gas resistivity, particulate conductivity must be maintained carefully.
- Poisonous gases are produced by the —ve charge discharge electrode during ionization.

CONVENTIONAL MUNICIPAL INCINERATOR

SOLID WASTE MANAGEMENT

The solid waste reaching the incinerator plant is generally quite wet & it is necessary to dry them before burning- of these wastes.

- The operation begins with unloading of solid waste from collection tanks into a storage bin.
- The length of the unloading platform and storage bin is a function of the number of trucks that must unload simultaneously.
- The over head crane is used to load the wastes into the charging hooper.
- From the Charging Hooper falls into the stoker where they are mass fired.
- Air may be introduced from the bottom of the grates to control furnace temperature.
- The gases are driven off into the combustion chamber taking place in the furnace where the temperature is about 1400°F.
- To meet the air pollution control regulations space must be provided for air cleaning equipments' as well as to supply air to incinerator itself by induced draft fan.

The end products of incineration are the cleaned gases that are discharged to the stock. Ashes& un burnt materials from the grates fall into a the ash tunnel located below the grates where they are quenched with water, fly ash particle settles in the combustion chamber which is removed by means of fly ash sluice way residue from the storage hopper may be taken to a sanitary landfill or to a resource recovery plant. Flash from the sluice way & the wastes from the air cleaning equipment are to a sanitary landfills.

notes4free.in

Merits

1. This is the most important method of waste disposal and ensures complete destruction of pathogenic bacteria.
2. There is no odour trouble or dust nuisance.
3. The disposal site can be conveniently located within the city.
4. It requires less space for refuse disposal.

Demerits

- It is very costly method.
- Transport vehicle are required in slightly large numbers.
- Solid waste to be burnt should have calorific value.

Part – B

UNIT – 5

Composting

Composting is a process in which organic materials undergo biological degradation to a stable nuisance free humus like end product.

The general objectives of composting are

- To transform the biodegradable organic materials into a biological stable materials and to reduce the original volume of waste.
- To destroy pathogens, insect eggs and other unwanted organism and weed seeds that may be present in waste.
- To retain the maximum nutrients content (nitrogen, phosphorous and potassium)
- To produce a product that can be used to support plant growth and as soil amendment.

➤ Aerobic Composting

Aerobic composting is the most commonly used biological processes for the conversion of the organic portion of solid waste to a stable humus like material known as compost. All aerobic composting processes are similar in that they all incorporate three basic steps.

- Preprocessing of the solid waste
 - Aerobic decomposition of the organic fraction of the solid waste
 - Product preparation and marketing.
- a. Aerobic composting is defined as a process in which, under suitable environmental condition, aerobic organisms principally thermophilic, utilize considerable amount of oxygen in decomposing organic matter to a fairly stable humus.
 - b. With the exception of plastic, rubber, and leather components, the organic fraction of most solid waste can be considered to be composed of carbohydrates, proteins, lipids, amino acids, cellulose, lignin and ash. If these organic materials are subjected to aerobic micro bacterial decomposition, the end product remaining after the microbial activity has essentially ceased is a humus material commonly known as compost.

Aerobic composting microbiology

- During composting process a succession of facultative and obligate aerobic micro organisms is active.
- In the beginning phases of composting process, mesophilic bacteria are most prevalent. After the rise in temperature of compost site, a thermophilic bacterium becomes predominate leading to thermophilic fungi which appear after 5 – 10 days.

- In final stages or curing period as it is sometimes known, actinomycetes appear. Because significant concentrations of these microorganisms may not be present in some types of biodegradable waste, it may be necessary to add them to the composting material as additive.
- Critical parameters in the control of aerobic composting processes include moisture content, c/n ratio and temperature.
- For most biodegradable organic wastes, once the moisture content is brought to a similar level (50 to 60%) and the mass is aerated, microbial metabolism speeds up.
- The aerobic microorganisms which utilize oxygen, feed upon the organic matter and develop cell tissue from nitrogen, phosphorous, some of the carbon and other required nutrients.
- Much of the carbon serves as a source of energy for the organism and is burnt up and respired as carbon dioxide.

➤ Anaerobic Composting

Anaerobic composting is the putrefactive break down of the organic matter by reduction in the absence of oxygen leading to the production of methane and carbon dioxide.

Process Microbiology

- The biological conversion of solid waste under anaerobic condition is thought to occur in three steps.
 1. The first step involves the enzyme mediated transformation of higher molecular mass compounds into compounds suitable for use as source of energy.
 2. The second step involves the bacterial conversion of the compounds resulting from first step into identifiable lower molecular mass compound.
 3. The third step involves the bacterial conversion of the intermediate compounds into simpler end product principally methane and carbon dioxide.

In anaerobic decomposition of wastes, no of anaerobic organisms work together to bring about conversion of organic portion of the wastes to a stable end product.

- One group of organisms is responsible for hydrolyzing organic polymer and lipids to basic structural building blocks such as fatty acids, monosaccharide's, amino acids and related compounds.
- Second group of anaerobic bacteria ferments the break down products from the first group to organic acids the most common of which is acetic acid. This group of microorganisms is called acidogens or acid formers.
- Third group of micro organisms converts the hydrogen and acetic acid formed by the acid formers to methane gas and carbon dioxide.
- The bacteria responsible for the conversion are strict anaerobes called methanogens or methane formers.

Methods of Composting.

➤ **Bangalore Process of Composting** — Anaerobic Composting Type

The solid waste is stabilized anaerobically in earthen trenches of 10*1.5m*1.5m deep.

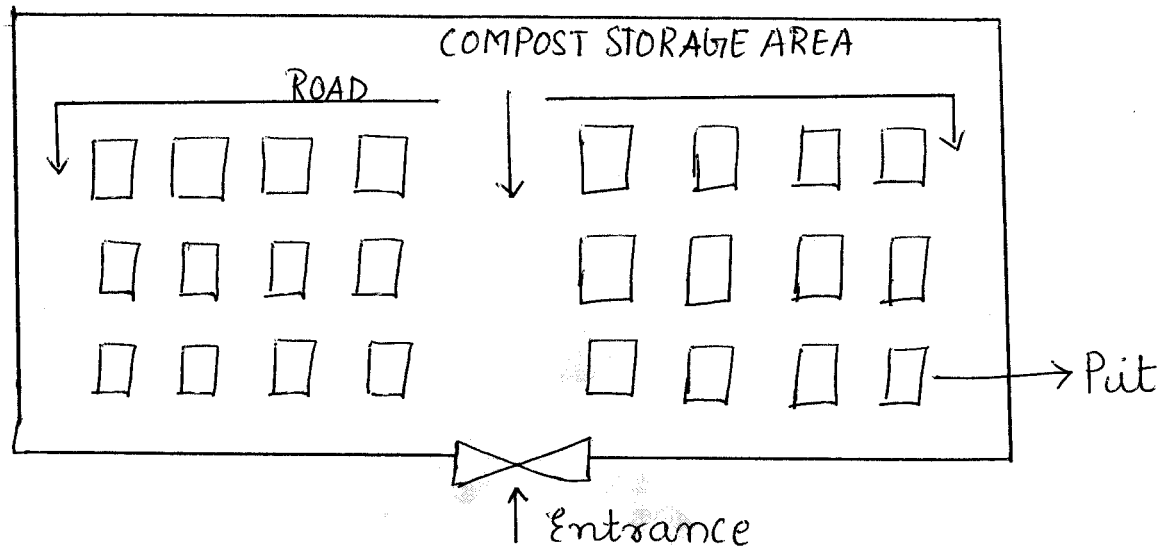

Process

1. A loose layer of solid waste is to be placed and spread at the bottom of the pit.
2. Succeeding layers of waste and night soil/ cow dung is placed. An alternative layer of waste and night soil of 5cm is placed until the layer is about 30cm above the ground surface. The top most layer of the waste should be at least 20cm thick.
3. The composting mass develops a temperature of about of 60°C in a few days.
4. After the material has been decomposed for several days, the volume decreases and the waste settles to one third to two third of the original depth. Again the new layers of night soil and waste can thus be added to the pit until the level is again 30cm above the ground.
5. The pile may be covered with 5cm layer of earth to prevent the escape of ammonia as well as to reduce the escape of odour.
6. The top 10 – 15cm of material in the pit do not decompose properly owing to lower temperature at the surface. This material is again reused for covering the pit
7. Fly control can be improved by covering the pit tightly with a cloth or sealed by a mud plaster.
8. After about 3-4months, the refuse gets finally stabilized and changes into brown colored odourless powdery mass called humus.

➤ Indore process of composting

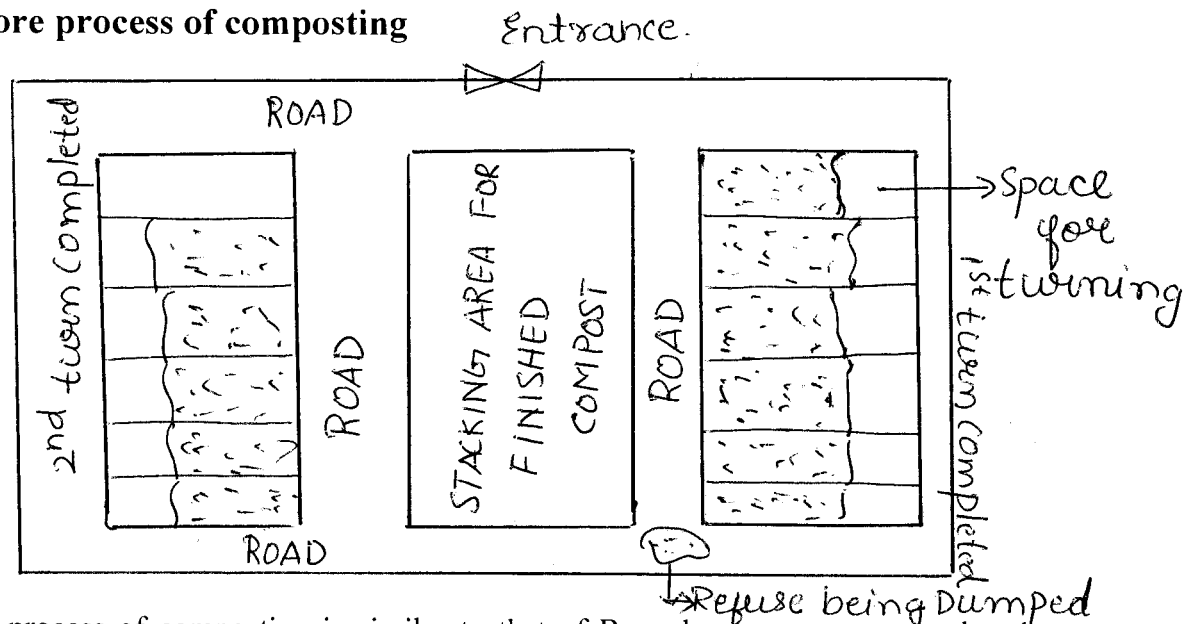

This process of composting is similar to that of Bangalore process except that the composting mass is returned. It is done to maintain aerobic condition and to keep away odour. It also helps in maintaining high temperature and uniform decomposition.

Process

1. The initial steps in placing the materials in the pit are more or less same as in the Bangalore process except that a small space about 60cm is left vacant at the end of the pit. The vacant space is used to facilitate turning of the compost materials. The thickness of the bottom and intermediate layers is kept slightly lesser to obtain slightly higher moisture content.
2. Since the material is turns, exposure of all the materials to high temperature is assured and high moisture content do not present any problems in maintaining aerobic condition.

After 4 to 7 days of loading the pit, contents must be turns. Turning process performs three functions.

- It completes the mixing of refuse and night soil.
- The materials at the top and sides of pit which are not subjected to high temperature are also subjected to high temperature.
- The materials are aerated which is an essential feature of aerobic stabilization.

Since the volume of the material shrinks during composting additional layers of night soil is added at the time of first turning. This process of turning is continued for about 4 to 5 weeks, during which time, the readily biodegradable organics are consumed. The waste compost mass is finally allowed to cure for another 2 to 8 weeks without any turning. The entire composting process, thus, takes about 3-4 months time to complete, after which the compost becomes ready for use.

➤ Mechanical and Semi mechanical process of composting

The Composting process involves four processes. Namely

- Receipt of refuse
 - Segregation
 - Grinding and pulverization
 - Digestion
- a) **Receipt of Refuse:** The refuse is received at the plant @ 2 to 6 tons per vehicle, and storage capacity at the plant should be about 25 to 50% of the daily arrival of refuse at the plant.
- b) **Segregation of Refuse:** Dry refuse is allowed to move along belt conveyor, where ferrous matter is removed by magnetic separator and other non combustible organic matters such as papers, rags, cardboard, non ferrous etc are separated out for recycling and reuse. The separation of such material can be done manually as well as shaker screens.
- c) **Grinding or pulverizing of refuse:** The remaining refuse is now pulverized by using different equipments like hammer mill, rasping machine, grinder etc.
- d) **Digestion of refuse:** The refuse is finally digested under controlled condition of temperature and moisture content in mechanical digestors.

The digestion is done in closed digester and opens windrow composting

notes4free.in

1. **Closed digester:** Closed digestors are the most hygienic and require minimum space, though costly and hence largely adopted in developed countries.
 - Digestion period in such digestors normally vary between 2 to 5days for refuse containing low cellulose or low c/n ratio; and 7 to 9days for refuse having more quantities of cellulose and higher c/n ratio.
 - In Closed digester plant, the refuse and garbage is processed in four stages.
 1. Is taken to a grinder
 2. Then to a bucket conveyor
 3. For segregation
 4. Finally to a closed digester containing rotating mechanism for thorough mixing of the refuse for its aerobic digestion under controlled condition of temperature and moisture.
 5. Such closed digestors may prove to be costly and hence uneconomical for composting large quantities of refuse, particularly for developing countries, like India

2. Open Windrow Composting: In this process the refuse is piled up in stacks. These stacks are called as windrows.

- The stacks should have the dimension of 1.5m height and 2.5m width. The moisture content should be 60%.

-
- The refuse is allowed in windrows and within one month duration the complete digestion is possible, after one month the nitrogen and phosphorous are added to compost to use as fertilizer.
 - Up to one month duration turning of refuse is required atleast twice or thrice a day.

➤ Vermicomposting

Vermicomposting uses natural composting process of decomposition of biodegradable organic matter by the soil bacteria as in ordinary composting technique, but takes the assistance of cultured earth worms that are produced commercially.

- These earth worms do help in quicker decomposition of the organic matter.
- This method helps in adopting the composting technique in individual bungalows and institution, to dispose of domestic waste and more particularly for disposing of the yard and garden wastes.

The various steps involved in applying the vermicomposting technique are summarized below.

- Dig a small pit about 0.5m square and 1m in deep.
- Line the pit with dried leaves and grass.
- Organize the disposal of organic domestic waste such as vegetable waste into the pit as and when generated.
- Introduce a culture of worms that is produced commercially.
- Cover the pit contents daily, by sprinkling of dried leaves and soil every day.
- Water the pit once or twice a week to keep it moist.
- Turn the contents of the pit every 15days.
- In about 45 days, the waste will be decomposed by the action of the microorganisms.
- The produced humus in the pit is fertile and rich in soil nutrients. It can, hence, be used in the garden.

➤ Factors affecting composting

The most important factors affecting the composting operations are given below.

1. Segregation of refuse
2. Grinding and shredding of refuse
3. C/N ratio
4. Proportion or blending of wastes
5. Moisture content
6. Placement of materials for composting
7. Temperature
8. Aeration
9. Organisms in composting
10. Reaction (pH value)
11. Climatic condition
12. Destruction of pathogenic organisms
13. Fly control

1. Segregation of refuse: Segregation is an important factor as they would create difficulties in subsequent process of composting.

Glass bottles, tin cans, plastic materials can be easily segregated.

2. Grinding and shredding of refuse: Grinding and shredding of refuse makes the material more susceptible to bacterial invasion as more area is exposed to bacterial attack.

3. C/N Ratio (Carbon/ Nitrogen Ratio): Decomposition of organic matter is affected by the presence of carbon and nitrogen. The c/n ratio represents the initial proportion of two elements.

- The decomposition of organic matter is brought about by living organisms which use 'c' as a source of energy and 'n' for building cell structure.
- Since each part of 'n', an initial c/n ratio of 30 seems most favorable for rapid composting.
- The composting can be decreased by decreasing c/n ratio below 30. This ratio largely depends upon the composition of the solid waste being composted.

4. Proportion or Blending of Wastes: C/N ratio and moisture content are the two factors which are to be considered in blending. There is no need for blending when c/n ratio lies between 30 – 40.

- Materials too dry for good composting and materials too wet to compost without nuisance should be blended in proper proportions
- Sometimes even earth is added to the organic materials with the idea of increasing the number of microorganisms so as to expedite composting.

5. Moisture content: Aerobic composting can proceed at any moisture content between 30% and 100% provided adequate aeration is maintained. But however a high moisture content must be avoided because water displaces air and availability of oxygen is decreased on the other hand, too low moisture content deprives the organisms of water needed for their metabolism.

- In aerobic composting, the maximum moisture content is not important. If the procedure is to have initial aerobic conditions to produce high temperature lasting a few days for the destruction of pathogenic organisms followed by aerobic composting, the maximum initial moisture content may be as high as 65 – 85% depending on the character of the composting.

6. Placement of Materials for composting: For the aerobic composting, solid wastes are placed in open pile or windrows placed on the ground or on a paved surface or in a shallow pit are the mostly used methods.

- If composting process is to be maintained aerobic throughout, frequent turning becomes essential. On the other hand if composting is to be entirely anaerobic, pits about 1m deep and varying in length and breadth in accordance with the daily quantity of waste.

7. Temperature: In aerobic composting proper temperature is a very important factor. High temperature is essential for the destruction of pathogenic organism and undesirable weed seed.

notes4free.in

- Composting also proceeds much more rapidly in the thermophilic temperature range. The optimum temperature ranges 55° - 70°c, around 60°c usually being satisfactory.
- A drop in temperature in the pile of wastes before the material is stabilized indicates that the pile is becoming anaerobic and should be aerated. The variations in moisture content between 30% and 75% have little effect on the maximum temperature.

8. Aeration: Aeration is essential for thermophilic aerobic composting and also for reducing the high initial moisture content. Aeration also avoids anaerobic condition, helps in maintaining high temperature and fly control.

9. Organisms in composting: In aerobic composting a wide variety of micro organism have a variety of specific functions. Compostable waste materials normally contain a large number of many different types of bacteria, fungi and other living organism.

10. Reaction (pH): The initial pH of compostable materials lies usually between 5 and 7. Waste containing ash may be having higher pH value. If the material has undergone putrefication before being received for composting pH will be about 5. Since the optimum pH for most organisms is around 6.5 to 7.5, it would be beneficial if pH could be maintained in that range.

11. Climatic conditions: Climatic condition like temperature, wind and rainfall influence the composting operation.

- Wind lowers the temperature on the windward side of the compost stack.
- Rain presents more of problems when composting done in pits.
- Heavy snowfall greatly hinders continuous composting operation.

12. Destruction of Pathogenic organisms: Aerobic composting of high temperature is effective in destroying pathogenic organisms. Almost all the disease bearing microorganism die away at much lower temperature than the maximum temperature found inside the composting piles. Frequent turning also helps in the elimination of disease producing organisms.

13. Fly control: The composting materials are excellent media for the breeding and development of a large fly population. Grinding, turning and systematic cleanliness are found and is most effective for controlling flies.

➤ **Important design consideration for anaerobic composting**

1. Size of materials – Wastes to be digested should be simplified into size that will not interfere with the efficient working or functioning of mixing operation.
2. Mixing equipment – To achieve optimum effects results and to avoid scum build up, mechanical mixing is recommended.
3. Percentage of solid wastes mixed with sludge – Although amounts of wastes varying from 50 to 90% have been used. 60% appears to be reasonable compromise.
4. Temperature -Between 30 - 38°C for mesophilic organism and 55 - 60°C for thermophilic organism.
5. Destruction of volatile solid waste – Depends upon the nature of characteristics destruction varies from about 60 to 80%, 70% can be used for estimating purpose.
6. Total solid destroyed – Varies from 40 to 60%, depending upon the amount of inert materials present originally.

➤ **Important design consideration for aerobic composting**

- 1) Particle size – For optimum results the size should be between 25 to 75mm.
- 2) Carbon/ nitrogen ratio – Initial carbon and nitrogen ratios between 25 and 50 are optimum for aerobic composting.
- 3) Blending and seeding – Composting time can be reduced by seeding with partially decomposed solid waste to a extent of about 1 to 5 percent the weight. Sewage sludge can also be added to prepared solid waste.
- 4) Moisture content – moisture content should be in range between 50 and 60% during the composting process. The optimum moisture content should be about 55%.
- 5) Mixing and turning – To prevent during, air channeling, material in the process of being compacted should be turns or mixed on regular schedule or as required.
- 6) Temperature – For best results, temperature should be maintained between 50 - 55°C for first few days and between 55 - 60°C for the remaining of the active composting. If temperature goes beyond 66°C, biological activity is reduced significantly.
- 7) Air requirement – The theoretical quantity of oxygen required can be estimated and air atleast 50% of the initial oxygen concentration of remaining should reach all parts of the composting material for optimum results.
- 8) pH Control – To achieve an optimum aerobic decomposition, pH should bremain at 7 to 7.5 range. To minimize the loss of nitrogen in the form of ammonia gas, pH should not rise above 8.5.
- 9) Land Requirement – The land requirement for a plant with a capacity of 50 tons/day will be 1.5 to 2 acres. The land area required for a larger plant will be less on ton/day basis.

Unit-5

* Problems :-

Estimating AIR Requirements

1. Determine the amount of air required to oxidize completely 1 tonne of waste having the chemical equation $C_{50}H_{100}O_{40}N$

Solu

- Oxygen required

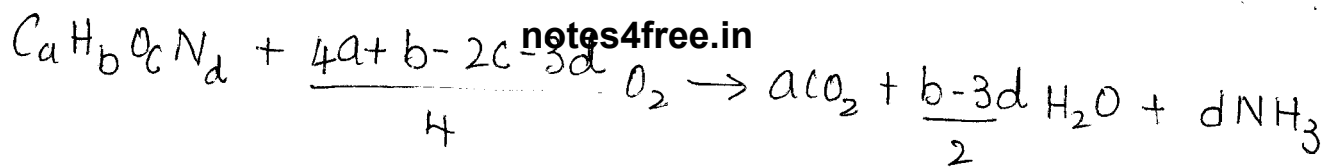

$$a=50; b=100; c=40; d=1$$

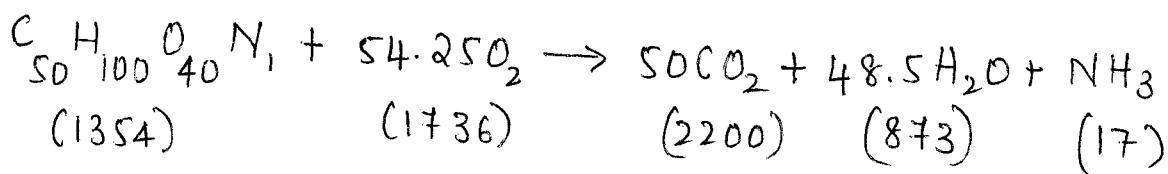

unit wt of carbon = 12
H = 1, O = 16, N = 14

Oxygen required / tonne

$$O_2 = \frac{1736}{1354} \times 1000 = 1.282 \times 10^3 \text{ kg/tonne}$$

$$O_2 = 1.282 \times 10^3 \text{ kg/tonne}$$

II Determine the O₂ Required to stabilize the ammonia

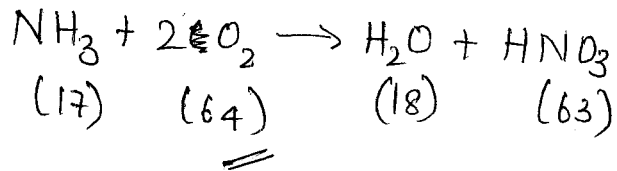

$$\text{O}_2 = \frac{17}{1354} \times \frac{64}{17} \times 1000 = \underline{47.3 \text{ kg/tonne}}$$

III Determine the amount of O₂ Required

- a) Density of air = 1.2928 kg/m³
air contains 23.15 percent O₂ by weight

$$\begin{aligned} \text{O}_2(\text{total}) &= (1.282 \times 10^3 + 47.3) \text{ kg/tonne} \\ &= \underline{1329.3 \text{ kg/tonne}} \end{aligned}$$

- b) The mass of air

$$\text{AIR}_{(\text{mass})} = \frac{1329.3 \text{ kg/tonne}}{0.2315}$$

$$= \underline{5742.11 \text{ kg/tonne}}$$

- c) Volume of air

$$\begin{aligned} V_{\text{air}} &= \frac{5742.11 \text{ kg/tonne}}{1.2928 \text{ kg/m}^3} \end{aligned}$$

$$\boxed{V_{\text{air}} = 4441.61 \text{ m}^3/\text{tonne}}$$

* Estimating methane production

1. Estimate the theoretical volume of methane gas that would be expected from the anaerobic digestion of a tonne of a waste having the composition $C_{50}H_{100}O_{40}N$

Solution:-

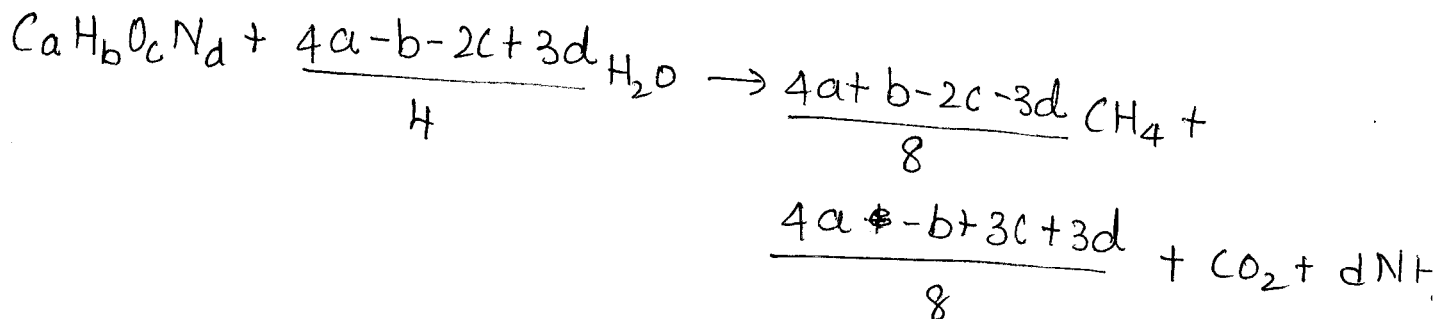

$$a = 50; b = 100; c = 40; d = 1$$

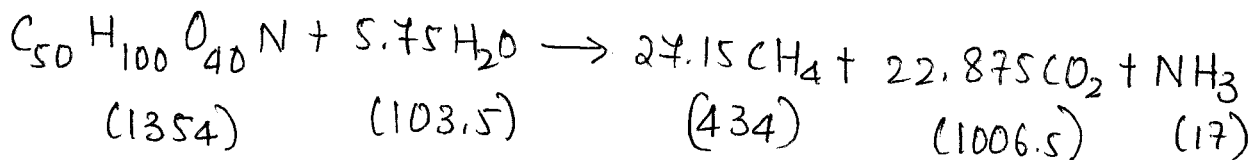

I Determine the mass of methane/tonne

$$\text{Methane} = \frac{434}{1354} \times 1000 = \underline{\underline{320.5 \text{ kg/tonne}}}$$

II Using a density value of 0.7167 kg/m^3

$$V = \frac{320.5 \text{ kg/tonne}}{0.7167 \text{ kg/m}^3}$$

$$V = \underline{\underline{44.72 \text{ m}^3 \text{ tonne of Waste}}}$$

notes4free.in

Unit – 6

Sanitary Landfill

Landfills have been the most economical and environmentally acceptable method for the disposal of solid waste. Even with the implementation of waste reduction, recycling and transformation technologies, disposal of residual solid waste still remains an important component of an integrated solid waste management. Landfill management incorporates planning, design, operation, closure and post closure control of landfills.

Based on the past experience throughout the world, land disposal in the form of sanitary landfill has proved to be most economical and acceptable method for the disposal of solid waste.

Definitions

1. Landfill – are the physical facilities used for the disposal of residual solid waste in the surface soil of earth.
2. Sanitary Landfill – An operation in which the waste to be disposed off are compacted and covered with the layer of soil at the end of each days operation. When the disposal site has reached its ultimate capacity ie after all disposal operations have been completed, a layer of 2ft or more material is applied.
Today sanitary landfill refers to an engineered facility for the disposal of soild waste designed and operated to minimize public health and environmental impacts.
3. Cell – It is used to describe volume of materials placed in a landfill during one operating period usually one day. It includes the solid waste deposited and also the daily cover materials surrounding it.
4. Daily cover – Usually consist of 6 – 12 inch of native soil or alternative soil such as compost that are applied to the working faces of the landfill at the end of each operating period. The purposes of daily cover are
 - To control the blowing of waste materials
 - To prevent the rats, flies & other disease vectors from entering the landfill.
 - To control the entry of water into the landfill during operation.
5. Lift – is a complete layer of cells over the active area of the landfill. Typically landfill are comprised of series of lifts.
6. Bench or terrace – is commonly used where the height of the landfill will exceed 50-75ft. Benches are used to maintain the slope stability of the landfill for the placement of surface water, drainage channel and for the location of landfill gas recovery piping.

-
7. Final cover layer – It is applied to entire landfill surface after all landfilling operation is complete. It usually consist of multiple layer of soil or geomembrane materials designed to enhance surface drainage, intercept percolating water and support surface vegetation.
 8. Leachate – The liquid that collects at the bottom of the landfill is known as leachate.
 - In general, leachate is a result of the percolation of precipitation, uncontrolled runoff and irrigation water into the landfill.
 - Leachate can also include water initially contained in the waste as well as infiltrating ground water.
 - Leachate contains a variety of chemical constituents derived from the solubilization of materials deposited in the landfill.
 9. Landfill gas - it is the mixture of gases formed within a landfill. The bulk of landfill gas consist of methane and carbon dioxide. Other components of landfill gas include ~~atmosphere~~, nitrogen, oxygen, ammonia and traces of organic compounds.
 10. Landfill liners – are the materials both natural and manufactured that are used to line the bottom area and below grade sites of a landfill. Liner usually consist of layers of compacted clay and geomembrane materials designed to prevent migration of landfill leachate and landfill gas.

❖ Advantages and disadvantages of Sanitary Landfill

Advantages

1. Where land is available, sanitary landfill is usually the most economical method of solid waste disposal.
2. The initial investment is low compared with other disposal methods like incineration or pulverization.
3. Sanitary landfill is a complete or final disposal method as compared to incineration and composting which require additional treatment .
4. Sanitary landfill can receive all types of solid waste eliminating the necessity of separate collection.
5. Sanitary landfill is flexible. Increased quantities of solid waste can be disposed off with little additional equipment.
6. Sub marginal land can be reclaimed as parking slots, play ground, golf courses etc..

Disadvantages

1. In highly populated areas suitable land may not be available within economical hauling distance.

-
2. Proper Sanitary landfill standards must be followed daily or the operation may result in an open dump.
 3. Sanitary landfill located in residential areas can provoke public opposition.
 4. A completed landfill will settle gradually and require periodic maintenance.
 5. Special design and construction is required for building constructed on completed landfill because of settlement factor.
 6. Methane an explosive gas and other gases produced from the decomposition of waste may become a hazard or nuisance.

❖ Site Selection

Factors that must be considered in evaluating potential solid waste disposal sites.

1. Available Land area – In selecting the disposal site, it is important to ensure that sufficient area is available. Although there are no fixed rules concerning the area required, it is desirable to have sufficient area including an adequate buffer zone to operate for at least five years at a given site.
2. Haul Distance – Length of haul significantly affects the overall design in the operation and will have significant impact on operating cost.
3. Soil condition & topography – Because it is necessary to cover the solid waste placed in the landfill each day and to provide final cover after landfilling operation is completed.
 - Data must be obtained on the characteristics of the soil in the area. The cover materials must be available at or near the site.
4. Climatic condition – Local weather condition must also be considered in the evaluation of potential sites. Provision must be made for wet weather condition.
5. Surface water hydrology – The surface water hydrology of the area is important in establishing the existing natural drainage & runoff characteristics that must be considered. Because mitigation measures must be developed to divert surface runoff from the landfill site.
6. Local Environmental conditions – Although it has been possible to build and operate landfill sites in close proximity to both residential & industrial developments, they must be operated very carefully if they are to be environmentally acceptable with respect to traffic, noise, odor, dust, air borne debris, health hazards etc. To minimize the impact of landfilling operations, landfills are now sited more in remote areas.
7. Ultimate use of completed landfill – one of the advantages of a landfill is that, once it is completed the area of land becomes available for other purposes. Because the ultimate use affects the design & operation of landfill, this issue must be resolved before the landfill & design of landfill is begun.
8. Site Access – as the number of operating landfill continues to decrease, new landfills that are sited are increasing in size because land areas of suitable size are not readily available near existing developed roadways and cities. Construction of

excess roadways and rail lanes has become a fact of life and an important part of landfill siting.

❖ Methodology

Placement of waste in the sanitary landfill

Once the landfill site has been prepared the next step in the process involves actual placement of waste materials.

- Solid waste is transported in trucks or tractor to the disposal site and dumped on low lying area i.e trenches.
- The waste is placed incense beginning along the face continuing upwards and outwards of the face.
- The waste deposited by vehicles is spread out in 18 – 24 inch layer and is compacted.
- The waste deposited in each operating period ie in one day forms an individual cell. Typical cell height varies from 8 – 12 feet.
- Length of working face varies from site condition & size of operation. The working face is the area of the landfill where the solid waste is unloaded, placed and compacted during a given operating period.
- All exposed face of the cell is covered with thin layer of soil 6 – 12inch thick at the end of each operating period.
- After one or more **notes4free.in** completed horizontal gas recovery trenches can be excavated in the completed surface. The trenches are filled with gravel and perforated plastic pipes are installed in trenches.
- Gas is extracted through pipes depending on the depth of landfill & additional leachate collection facilities may be placed in lifts.
- A cover layer is applied to the completed landfill section. The final cover is designed to minimize infiltration of leachate and drainage.
- Vertical gas extraction systems may be installed through completed landfill surface and the whole system is tied together and routed to energy recovery facilities.

❖ Sanitary Land filling Methods

The principal methods used for the land filling of solid waste are

1. Trench / excavated method
2. Area / ramp method
3. Canyon / Depression method

1. **Excavated / Trench method** – The excavated cell/ trench method of landfilling is ideally suited through areas where an adequate depth of cover material is available at the site and where water table is not near the ground surface.

- Typically solid wastes are placed in cells or trench excavated in the soil. The soil excavated from the site is used for daily and final cover. The excavated cell/ trench are usually lined with synthetic membrane liners or low permeability clay or combination of both to limit the movement of landfill gases and leachate. Excavated cells are typically square, up to 1000ft in width and length with side slopes of 1.5:1 to 2:1 in length, 3- 10ft in depth and 15- 50ft in width.

Landfills are allowed to construct below the high ground water level if special provisions are made to prevent ground water from entering the landfill and to contain or eliminate the movement of leachate or gases from completed cells. Usually the site is dewatered, excavated and lined in compliance with local regulation. The dewatering facilities are operated until the site is filled to avoid the creation of uplift pressures that would cause the liner to heave and rupture.

notes4free.in

2. **Area / Ramp method** – is used when the terrain is unsuitable for the excavation of cells or trenches in which to place the solid waste. In high ground water conditions necessitates the use of area method.

- Landfill site preparation includes the installation of liner and leachate control system.
- Cover material is hauled in by trucks and earth moving equipments from adjacent land or from borrow pit areas.
- In location with limited availability of materials that can be used as cover, compost produced from yard waste and municipal solid waste has been used successfully as intermediate cover material.
- Other techniques that have been used include the use of movable temporary cover materials such as soil and geomembrane.
- Soil and geomembrane placed temporarily over a completed cell can be removed before the next lift is begun.

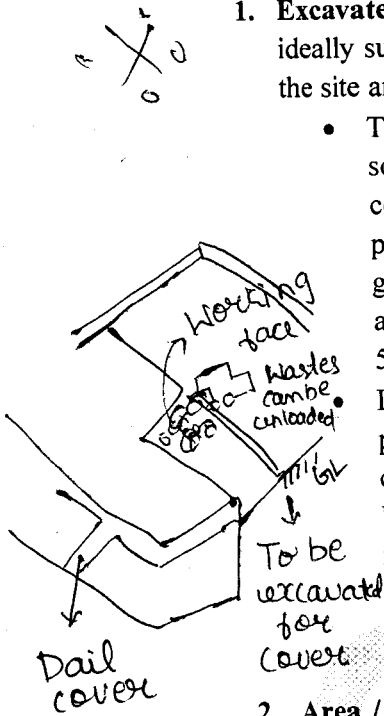

Gases

Composition – Landfill gas is composed of number of gases that are present in large amount and no of gases present in small amount. The principal gases are produced by the decomposition of solid wastes. Some of the trace, although present in small quantities may be toxic and could present risk to public health.

Principal Landfill Gas constituents

Gases found in landfill include NH_3 , CO_2 , CO , H_2S , CH_4 , H_2 and O_2 . CH_4 & CO_2 are the principal gases produced from anaerobic decomposition of biodegradable organic components in solid wastes. When CH_4 is present in air in concentration between 5 – 15% it is explosive because only limited amount of oxygen is present in landfill when CH_4 concentration reaches critical level. There is little danger that the landfill will explode. However CH_4 mixtures in explosive range can form, if landfill gases migrates offsite and mixes with air. The concentration of these gases that may be expected in the leachate will depend on their concentration in gas phase in contact with leachate.

Control of Gas movement

The movement of gases in landfills can be controlled by constructing vents and barriers and by gas recovery system.

- Control of Gas movement with Vents and barriers

Vents

notes4free.in

The lateral gas movement of gases produced in a landfill can be controlled by installing vents made of materials that are more permeable than the surrounding soil.

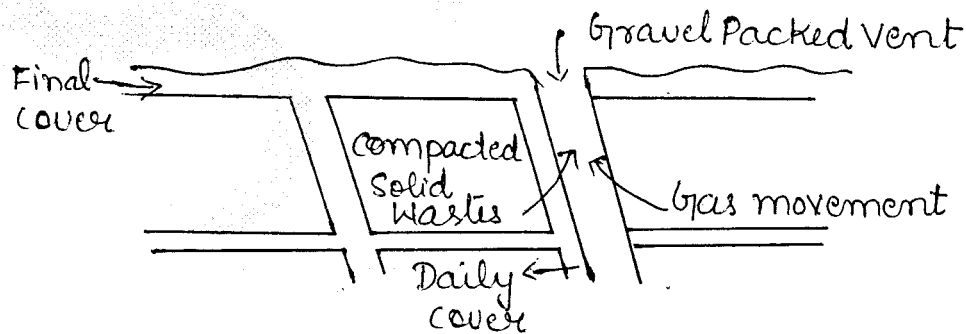

1. Gas vents are constructed of gravel.
2. The spacing of cell vents depends on the width of waste cells but usually varies from 18 – 60m. The thickness of gravel layer should be such that it will remain continuous even though there may be differential settlement.

Barriers or Well Vents – can be used to control the lateral movement of gases. Well vents are often used in conjunction with lateral surface vents buried below grade in a gravel trench to control the downward movement of gas which can be accomplished by installing perforated pipes.

- If the gases cannot be vented laterally, it may be necessary to install gas wells and to vent the pumped gas to the atmosphere.

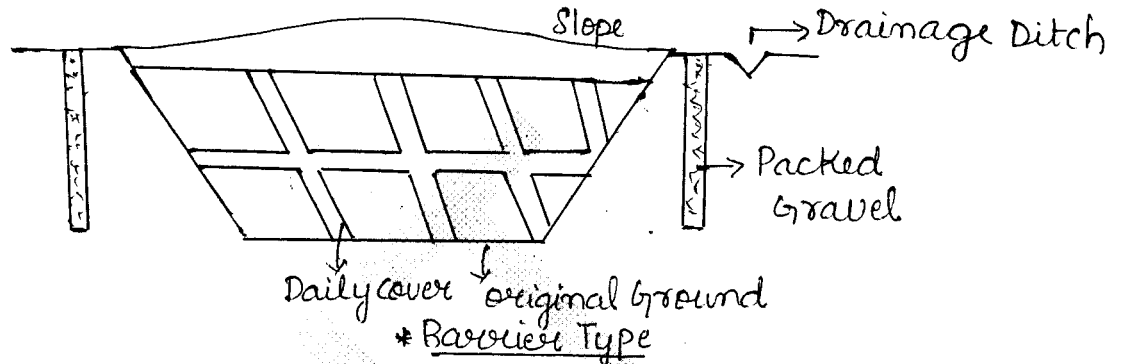

- The movement of landfill gases through adjacent soil formations can be controlled by constructing barriers of materials that are made impermeable than the soil.
- Some of the landfill sealants that are available for the use are bentonite, kaolinite, sodium carbonate, silicate, rubber latex, polymer etc.

Control of gas movement by gas recovery

The movement of gases in landfills can also be controlled by installing gas recovery wells in completed landfills

- Clay and other liners are used where landfill gas is to be recovered.
- In some gas recovery systems, leachate is collected and recycled to the top of the landfill and reinjected through perforated lines located in drainage trenches. Typically, the rate of gas production is greater in leachate recirculation system or where water is added.
- Although gas recovery systems have been installed in some large municipal landfills, the economics of such operations are at present not well defined.
- The cost of gas clean up and processing equipment may limit the recovery of landfill gases especially from small landfills.

* Well System for Gas Recovery System.

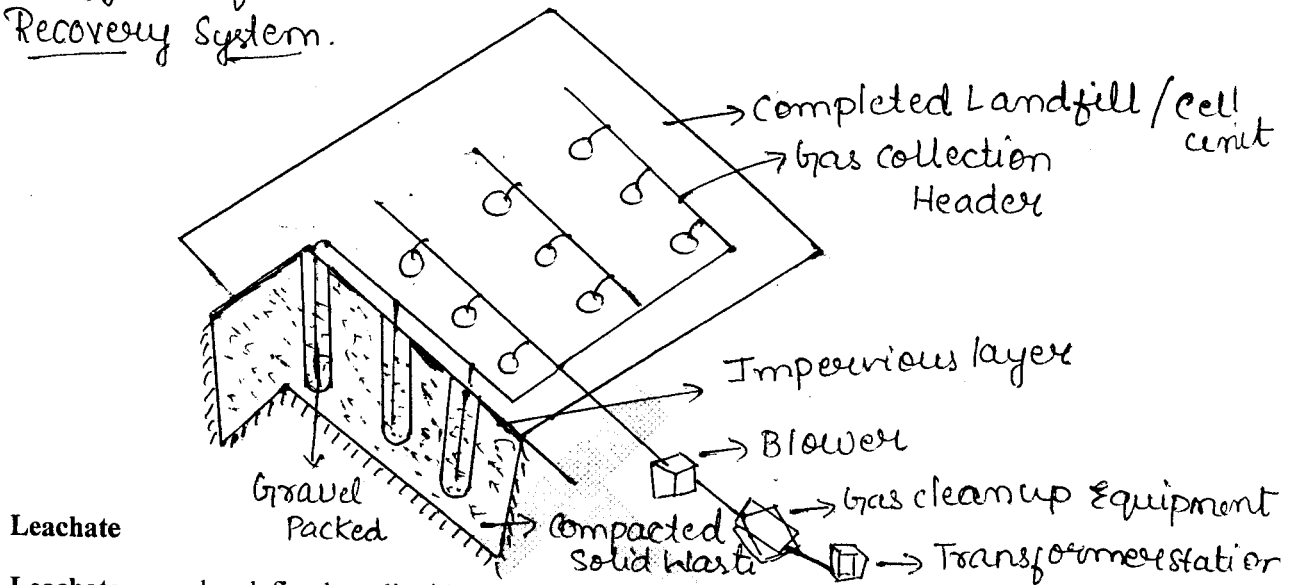

Leachate

Leachate may be defined as liquid that has percolated through solid waste and has extracted dissolved and suspended materials and is composed of the liquid that has entered the landfill from external sources such as surface drainage, rainfall, ground water and water from underground springs and liquid produced from decomposition of solid waste.

Leachate Movement – Under normal conditions, leachate is found at the bottom of landfill. From there, its movement is through the underlying strata, although some lateral movement may also occur depending on the characteristics of the surrounding material. The rate of seepage of leachate from the bottom of a landfill can be estimated by darcy's law by assuming that the material below the landfill to the top of the watertable is saturated and that a small layer of leachate exists at the bottom of landfill.

Control of Leachate movement – As leachate percolates through the underlying strata, many of the chemical and biological constituents originally contained in it will be removed by filtering and adsorptive action of the material composing the strata.

- In general, the extent of the action depends on the characteristics' of the soil, especially the clay content. Because of the potential risk involved in allowing leachate to percolate to the ground water, best practice calls for its elimination or containment. Ultimately, it may be necessary to collect and treat the leachate.
- The use of clay has been favored method of reducing or eliminating the percolation of leachate. Membrane liners have also been used, but they are expensive and require care so that they will not be damaged during the filling operation.
- Important in controlling the movement of leachate is the elimination of surface infiltration, which is the major contributor to the total volume of leachate.
- With the use of an impermeable clay layer, appropriate surface slope and adequate drainage surface infiltration can be controlled effectively.

Unit-6

1. Determine landfill area required for a municipality with a population 50,000, given that
- Solid Waste generation = 350 gm/person/day
 - Compacted density of Landfill = 504 kg/m³
 - Average depth of compacted S.W. = 3

Solution:-

I calculation of total amount of solid waste generation in a day.

$$\begin{aligned}\text{Total Waste} &= \text{Population} \times \text{per capita generation} \\ &= 50,000 \times 350 = 17.5 \times 10^3 \text{ kg/day}\end{aligned}$$

II calculation of volume of SW

$$\begin{aligned}\text{Volume} &= \frac{\text{Total amount of SW}}{\text{Compacted density}} \\ &= \frac{17500 \text{ kg/day}}{504 \text{ kg/m}^3} = 34.72 \text{ m}^3/\text{day}\end{aligned}$$

III calculation of landfill area

$$\text{Average depth} = 3 \text{ m}$$

$$\text{Total landfill area} = \frac{34.72}{3} = 11.57 \text{ m}^2$$

$$\text{Area} = 11.57 \text{ m}^2$$

notes4free.in

SOLID WASTE MANAGEMENT

MODULE-4

HAZARDOUS WASTE

Hazardous wastes refer to wastes that may, or tend to cause adverse health effects on the ecosystem and human beings. These wastes pose present or potential risks to human health or living organisms, due to the fact that they:

- are non-degradable or persistent in nature
- can be biologically magnified
- Are highly toxic and even lethal at very low concentrations.

Identification

By using either or both of the following criteria, we can identify as to whether or not a waste is hazardous:

- The list provided by government agencies declaring that substance as hazardous.
- Characteristics such as ignitability, corrosivity, reactivity and toxicity of the substance.

Characteristics of hazardous wastes

notes4free.in

The regulations define characteristic hazardous wastes as wastes that exhibit measurable properties posing sufficient threats to warrant regulation. For a waste to be deemed a characteristic hazardous waste, it must cause, or significantly contribute to, an increased mortality or an increase in serious irreversible or incapacitating reversible illness, or pose a substantial hazard or threat of a hazard to human health or the environment, when it is improperly treated, stored, transported, disposed of, or otherwise mismanaged.

1. **Ignitability:** A waste is an ignitable hazardous waste, if it has a flash point of less than 60C; readily catches fire and burns so vigorously as to create a hazard or is an ignitable compressed gas or an oxidizer. A simple method of determining the flash point of a waste is to review the material safety data sheet, which can be obtained from the manufacturer or distributor of the material. Naphtha, lacquer thinner, epoxy resins, adhesives and oil based paints are all examples of ignitable hazardous wastes.
2. **Corrosivity:** A liquid waste which has a pH of less than or equal to 2 or greater than or equal to 12.5 considered to be a corrosive hazardous waste. Sodium hydroxide, a caustic solution with a high pH, is often used by many industries to clean or degrease metal parts. Hydrochloric acid, a solution with a low pH, is used by many industries to clean metal parts prior to painting. When these caustic or acid solutions are disposed of, the waste is a corrosive hazardous waste.

SOLID WASTE MANAGEMENT

3. **Reactivity:** A material is considered a reactive hazardous waste, if it is unstable, reacts violently with water, generates toxic gases when exposed to water or corrosive materials, or if it is capable of detonation or explosion when exposed to heat or a flame. Examples of reactive wastes would be waste gunpowder, sodium metal or wastes containing cyanides or sulphides.
4. **Toxicity:** To determine if a waste is a toxic hazardous waste, a representative sample of the material must be subjected to a test conducted in a certified laboratory. The toxic characteristic identifies wastes that are likely to leach dangerous concentrations of toxic chemicals into ground water.

CLASSIFICATION OF HAZARDOUS WASTE

Hazardous wastes are classified as:

1. **Radioactive substance:** Substances that emit ionizing radiation are radioactive. Such substances are hazardous because prolonged exposure to radiation often results in damage to living organisms. Radioactive substances are of special concern because they persist for a long period.
2. **Chemicals:** Most hazardous chemical wastes can be classified into four groups: synthetic organics, inorganic metals, salts, acids and bases, and flammables and explosives. Some of the chemicals are hazardous because they are highly toxic to most life forms. When such hazardous compounds are present in a waste stream at levels equal to, or greater than, their threshold levels, the entire waste stream is identified as hazardous.
3. **Biomedical wastes:** The principal sources of hazardous biological wastes are hospitals and biological research facilities. This group mainly includes malignant tissues discarded during surgical procedures and contaminated materials, such as hypodermic needles, bandages and outdated drugs.
4. **Flammable wastes:** Most flammable wastes are also identified as hazardous chemical wastes. This dual grouping is necessary because of the high potential hazard in storing, collecting and disposing of flammable wastes. These wastes may be liquid, gaseous or solid, but most often they are liquids. Typical examples include organic solvents, oils, plasticizers and organic sludge's.
5. **Explosives:** Explosive hazardous wastes are mainly ordnance (artillery) materials, i.e., the wastes resulting from ordnance manufacturing and some industrial gases. Similar to flammables, these wastes also have a high potential for hazard in storage, collection and disposal, and therefore, they should be considered separately in addition to being listed as hazardous chemicals. These wastes may exist in solid, liquid or gaseous form.

SOLID WASTE MANAGEMENT

Sources of Hazardous Waste

The term hazardous waste often includes by-products of industrial, domestic, commercial, and health care activities. Rapid development and improvement of various industrial technologies, products and practices may increase hazardous waste generation. Major hazardous waste sources and their pollution routes in the environment are listed below.

- **Agricultural land and agro-industry:** Hazardous wastes from agricultural land and agro-industry can expose people to pesticides, fertilizers and hazardous veterinary product wastes. Farms are a major source of these wastes, and agrochemicals can leach into the environment while in storage or can cause damage after their application.
- **Domestic:** Households stock various hazardous substances such as batteries and dry cells, furniture polishes, wood preservatives, stain removers, paint thinners, rat poisons, herbicides and pesticides, mosquito repellents, paints, disinfectants, and fuels (i.e. kerosene) and other automotive products. These can present a variety of dangers during storage, use and disposal.
- **Mines and mineral processing sites:** Mining and mineral processing sites handle hazardous products that are present in the additives, the products and the wastes.
- **Health care facilities:** Health care facilities are sources of pathological waste, human blood and contaminated needles. Specific sources of these wastes include dentists, morticians, veterinary clinics, home health care, blood banks, hospitals, clinics and medical laboratories.
- **Commercial wastes:** Commercial waste sources include gasoline stations, dry cleaners and automobile repair shops (workshops). The types of hazardous wastes generated by these sources depend on the services provided.
- **Institutional hazardous waste sources:** Institutional hazardous waste sources are mainly research laboratories, research centers and military installations. Some military installations are used for the manufacture and storage of ammunition, and they are also used as testing grounds for military hardware. Military establishments also carry out activities that generate other types of hazardous wastes of household, commercial and industrial nature.
- **Industrial hazardous waste sources:** Hazardous wastes are created by many industrial activities. For example, the hazardous wastes from the petroleum fuel industry include the refinery products (fuels and tar), impurities like phenol and cyanides in the waste stream, and sludge flushed from the storage tanks.
- **Solid waste disposal sites:** These are mainly disposal sites for municipal solid waste, but hazardous wastes that have not been properly separated from other wastes are also at these sites. In developing countries, solid waste disposal sites are a major source of pollutant-laden leachate to surrounding areas, as well as recyclable materials for scavengers, who can collect and resell waste materials that have been exposed to or that contain hazardous substances.

SOLID WASTE MANAGEMENT

Sources of Hazardous waste

Waste Category	Sources
Radioactive substances	Biomedical research facilities, colleges and university laboratories, offices, hospitals, nuclear power plants, etc.
Toxic chemicals	Agricultural chemical companies, battery shops, car washes, chemical shops, college and university laboratories, construction companies, electric utilities, hospitals and clinics, industrial cooling towers, newspaper and photographic solutions, nuclear power plants, pest control agencies, photographic processing facilities, plating shops, service stations, etc.
Biological wastes	Biomedical research facilities, drug companies, hospitals, medical clinics, etc.
Flammable wastes	Dry cleaners, petroleum reclamation plants, petroleum refining and processing facilities, service stations, tanker truck cleaning stations, etc.
Explosives	Construction companies, dry cleaners, ammunition production facilities, etc.

Storage and collection of Hazardous waste

Onsite storage practices are a function of the types and amounts of hazardous wastes generated and the period over which generation occurs. Usually, when large quantities are generated, special facilities are used that have sufficient capacity to hold wastes accumulated over a period of several days. When only a small amount is generated, the waste can be containerized, and limited quantity may be stored. Containers and facilities used in hazardous waste storage and handling are selected on the basis of waste characteristics. For example, corrosive acids or caustic solutions are stored in fibre glass or glass-lined containers to prevent deterioration of metals in the container. Great care must also be exercised to avoid storing incompatible wastes in the same container or locations.

Typical drum containers used for the storage of hazardous waste:

Light-Gauge Closed Head Drum

Light-Gauge Open Head Drum

The waste generator, or a specialized hauler, generally collects the hazardous waste for delivery to a treatment or disposal site. The loading of collection vehicles is completed in either of the following ways:

- Wastes stored in large-capacity tanks are either drained or pumped into collection vehicles;

SOLID WASTE MANAGEMENT

- Wastes stored in sealed drums or sealed containers are loaded by hand or by mechanical equipment onto flatbed trucks.

The stored containers are transported unopened to the treatment and disposal facility. To avoid accidents and the possible loss of life, two collectors should be assigned when hazardous wastes are to be collected. The equipment used for collection vary with the waste characteristics.

Equipment for Collection of Hazardous Waste

Waste Category	Collection equipment and accessories
Radioactive substances	Various types of trucks and railroad equipment depending on characteristics of wastes; special marking to show safety hazard; heavy loading equipment to handle concrete-encased lead containers.
Toxic chemicals	Flatbed trucks for wastes stored in drums; tractor-trailer tank truck combination for large volumes of wastes; railroad tank cars; special interior linings such as glass, fibreglass or rubber.
Biological wastes	Standard packers' collection truck with some special precautions to prevent contact between wastes and the collector; flatbed trucks for wastes stored in drums.
Flammable wastes	Same as those for toxic chemicals, with special colorings and safety warning printed on vehicles.
Explosives	Same as those for toxic chemicals with some restriction on transport routes, especially through residential areas.

HAZARDOUS WASTE TREATMENT

The various options for hazardous waste treatment can be categorized under physical, chemical, thermal and biological treatments.

Physical and chemical treatment

1. **Filtration and separation:** Filtration is a method for separating solid particles from a liquid using a porous medium. The driving force in filtration is a pressure gradient, caused by gravity, centrifugal force, vacuum, or pressure greater than atmospheric pressure. The application of filtration for treatment of hazardous waste fall into the following categories:
 - **Clarification**, in which suspended solid particles less than 100 ppm (parts per million) concentration are removed from an aqueous stream. This is usually accomplished by depth filtration and cross-flow filtration

SOLID WASTE MANAGEMENT

and the primary aim is to produce a clear aqueous effluent, which can either be discharged directly, or further processed. The suspended solids are concentrated in a reject stream.

- **Dewatering** of slurries of typically 1% to 30 % solids by weight. Here, the aim is to concentrate the solids into a phase or solid form for disposal or further treatment. This is usually accomplished by cake filtration. The filtration treatment, for example, can be used for neutralization of strong acid with lime or limestone, or precipitation of dissolved heavy metals as carbonates or sulphate followed by settling and thickening of the resulting precipitated solids as slurry. The slurry can be dewatered by cake filtration and the effluent from the settling step can be filtered by depth filtration prior to discharge
2. **Chemical precipitation:** This is a process by which the soluble substance is converted to an insoluble form either by a chemical reaction or by change in the composition of the solvent to diminish the solubility of the substance in it. Settling and/or filtration can then remove the precipitated solids. In the treatment of hazardous waste, the process has a wide applicability in the removal of toxic metal from aqueous wastes by converting them to an insoluble form. This includes wastes containing arsenic, barium, cadmium, chromium, copper, lead, mercury, nickel, selenium, silver, thallium and zinc. The sources of wastes containing metals are metal plating and polishing, inorganic pigment, mining and the electronic industries. Hazardous wastes containing metals are also generated from cleanup of uncontrolled hazardous sites, e.g., leachate or contaminated ground water.
 3. **Chemical oxidation and reduction (redox):** In these reactions, the oxidation state of one reactant is raised, while that of the other reactant is lowered. When electrons are removed from an ion, atom, or molecule, the substance is oxidised and when electrons are added to a substance, it is reduced. Such reactions are used in treatment of metal-bearing wastes, sulphides, cyanides and chromium and in the treatment of many organic wastes such as phenols, pesticides and sulphur containing compounds. Since these treatment processes involve chemical reactions, both reactants are generally in solution. However, in some cases, a solution reacts with a slightly soluble solid or gas.
 4. **Evaporation:** Evaporation is defined as the conversion of a liquid from a solution or slurry into vapour. All evaporation systems require the transfer of sufficient heat from a heating medium to the process fluid to vaporise the volatile solvent. Evaporation is used in the treatment of hazardous waste and the process equipment is quite flexible and can handle waste in various forms – aqueous, slurries, sludges and tars. Evaporation is commonly used as a pre-treatment method to decrease quantities of material for final treatment. It is also used in cases where no other treatment method was found to be practical, such as in the concentration of trinitrotoluene (TNT) for subsequent incineration.

SOLID WASTE MANAGEMENT

Thermal treatment

Incineration: Incineration can be regarded as either a pre-treatment of hazardous waste, prior to final disposal or as a means of valorizing waste by recovering energy. It includes both the burning of mixed solid waste or burning of selected parts of the waste stream as a fuel. The concept of treating hazardous waste is similar to that of municipal solid waste.

Pyrolysis: This is defined as the chemical decomposition or change brought about by heating in the absence of oxygen. This is a thermal process for transformation of solid and liquid carbonaceous materials into gaseous components and the solid residue containing fixed carbon and ash. The application of pyrolysis to hazardous waste treatment leads to a two-step process for disposal. In the first step, wastes are heated separating the volatile contents (e.g., combustible gases, water vapour, etc.) from non-volatile char and ash. In the second step volatile components are burned under proper conditions to assure incineration of all hazardous components.

To elaborate, pyrolysis is applicable to hazardous waste treatment, as it provides a precise control of the combustion process. The first step of pyrolysis treatment is endothermic and generally done at 425 to 760C. The heating chamber is called the pyrolyser. Hazardous organic compounds can be volatilized at this low temperature, leaving a clean residue. In the second step, the volatiles are burned in a fume incinerator to achieve destruction efficiency of more than 99%. Separating the process into two very controllable steps allows precise temperature control and makes it possible to build simpler equipment. Pyrolysis process can be applied to solids, sludge's and liquid wastes. Wastes with the following characteristics are especially amenable to pyrolysis:

- Sludge material that is either too viscous, too abrasive or varies too much in consistency to be atomized in an incinerator.
- Wastes such as plastic, which undergo partial or complete phase changes during thermal processing.
- High-residue materials such as high-ash liquid and sludge's, with light, easily entrained solids that will generally require substantial stack gas clean up.
- Materials containing salts and metals, which melt and volatilize at normal incineration temperatures. Materials like sodium chloride (NaCl), zinc (Zn) and lead (Pb), when incinerated may cause refractory spalling and fouling of the heat-exchanger surface.

Biological treatment

1. **Land treatment:** This is a waste treatment and disposal process, where a waste is mixed with or incorporated into the surface soil and is degraded, transformed or immobilised through proper management. The other terminologies used commonly include land cultivation, land farming, land application and sludge spreading. Compared to other land disposal options (e.g., landfill and surface impoundments), land treatment has lower long-

SOLID WASTE MANAGEMENT

term monitoring, maintenance and potential clean up liabilities and because of this, it has received considerable attention as an ultimate disposal method. It is a dynamic, management-intensive process involving waste, site, soil, climate and biological activity as a system to degrade and immobilise waste constituents. In land treatment, the organic fraction must be biodegradable at reasonable rates to minimise environmental problems associated with migration of hazardous waste constituents.

2. **Enzymatic systems:** Enzymes are complex proteins ubiquitous in nature. These proteins, composed of amino acids, are linked together via peptide bonds. Enzymes capable of transforming hazardous waste chemicals to non-toxic products can be harvested from microorganisms grown in mass culture. Such crude enzyme extracts derived from microorganisms have been shown to convert pesticides into less toxic and persistent products. The reaction of detoxifying enzymes are not limited to intracellular conditions but have been demonstrated through the use of immobilised enzyme extracts on several liquid waste streams. The factors of moisture, temperature, aeration, soil structure, organic matter content, seasonal variation and the availability of soil nutrients influence the presence and abundance of enzymes.

Disposal

notes4free.in

Regardless of their form (i.e., solid, liquid, or gas), most hazardous waste is disposed off either near the surface or by deep burial.

Although, controlled landfill methods have been proved adequate for disposing of municipal solid waste and limited amounts of hazardous waste, they are not suitable enough for the disposal of a large quantity of hazardous waste, due to the following reasons:

- possible percolation of toxic liquid waste to the ground water;
- dissolution of solids followed by leaching and percolation to the ground water;
- potential for undesirable reactions in the landfill that may lead to the development of explosive or toxic gases;
- Corrosion of containers with hazardous wastes.

SOLID WASTE MANAGEMENT

E-WASTE

Electronics Waste: Popularly known as E Waste can be defined as electronic and electrical equipment's / Products (Including the connecting power plug and batteries) which has been obsolete due to:

- i. Changes in fashion, style and status
- ii. Nearing the end of their useful lives

EFFECT OF E-WASTE ON ENVIRONMENT

Element	Effect on environment
Lead	Damage to central and peripheral nervous systems, blood systems and kidney damage. Affects brain development of children
Chromium	Asthmatic bronchitis. DNA damage
Cadmium	Toxic irreversible effects on human health. Accumulates in kidney and liver. Causes neural damage. Teratogenic
Mercury	Chronic damage to the brain. Respiratory and
Plastics including PVC	Burning produces dioxin. It causes reproductive and developmental problems; Immune system damage; Interfere with regulatory hormones

Effects on Human Health

Plastic	Adverse Health Effects
Polyvinylchloride	Cancer, birth defects, vision failure, ulcers
Phthalates (DEHP, DINP)	Endocrine disruption, asthma, hormonal changes
Polycarbonate	Cancer, obesity, diabetes, hyperactivity
Polystyrene	Irritate eyes, nose and throat, dizziness
Polyethylene	Human carcinogen
Urea formaldehyde	Carcinogen, birth defects and genetic changes
Polyurethane Foam	Bronchitis, coughing, shin and eye problem
Acrylic	Vomiting, diarrhoea, nausea, headache and fatigue
Tetrafluoro Ethelyn	Breathing difficulties

SOLID WASTE MANAGEMENT

Treating E-Waste

As of now, there are no proper methods being implemented even in the first world to eliminate the problem of e-waste.

- The two methods found to be interesting for proper treatment of e-waste are **recycling** and **refurbishing**.
- For recycling, there may be products that cannot be recycled completely. PVC layers, for example, stay as such for ages and cannot be recycled. It would be better if the manufacturers use recyclable material so that the e-waste is converted into something that can be used again without harming the planet and its inhabitants. Thus, one of the major factors in treating e-waste is to compel manufacturers to use green elements.
- If electronics are refurbished, they can be sold again at a lower price. Thus, both the society and environment will benefit. Instead of simply dumping your old TV into the garbage bin, you might want to think about calling the vendor and ask him where to present the item for refurbishing. If you cannot find, consider donating the item to some charity that can either use it as such or get it repaired and use it. I do not think it is a practice well implemented, but it would be nice if all vendors provide a refurbishing facility.

E -Waste Disposal Methods

- **LANDFILLING**

This is the most common methodology of e-waste disposal. Soil is excavated and trenches are made for burying the e-waste in it. An impervious liner is made of clay or plastic with a leachate basin for collection and transferring the e-waste to the treatment plant. However, landfill is not an environmentally sound process for disposing off the e-waste as toxic substances like cadmium, lead and mercury are released inside the soil and ground water.

- **ACID BATH**

Acid bath involves soaking of the electronic circuits in the powerful sulphuric, hydrochloric or nitric acid solutions that free the metals from the electronic pathways. The recovered metal is

SOLID WASTE MANAGEMENT

used in the manufacturing of other products while the hazardous acid waste finds its ways in the local water sources.

- **INCINERATION**

This is a controlled way of disposing off the e-waste and it involves combustion of electronic waste at high temperature in specially designed incinerators. This e-waste disposal method is quite advantageous as the waste volume is reduced extremely much and the energy obtained is also utilized separately. However, it is also not free from disadvantages with the emission of the harmful gases mercury and cadmium in the environment.

Step-by Step Process of E-waste Recycling

The e-waste recycling process is highly labor intensive and goes through several steps. Below is the step-by-step process of how e-waste is recycled,

1. **Picking Shed** - When the e-waste items arrive at the recycling plants, the first step involves sorting all the items manually. Batteries are removed for quality check. **notes4free.in**
2. **Disassembly** - After sorting by hand, the second step involves a serious labor intensive process of manual dismantling. The e-waste items are taken apart to retrieve all the parts and then categorized into core materials and components. The dismantled items are then separated into various categories into parts that can be re-used or still continue the recycling processes.
3. **First size reduction process** -Here, items that cannot be dismantled efficiently are shredded together with the other dismantled parts to pieces less than 2 inches in diameter. It is done in preparation for further categorization of the finer e-waste pieces.
4. **Second size reduction process** - The finer e-waste particles are then evenly spread out through an automated shaking process on a conveyor belt. The well spread out e-waste pieces are then broken down further. At this stage, any dust is extracted and discarded in a way that does not degrade the environmentally.
5. **Over-band Magnet** - At this step, over-band magnet is used to remove all the magnetic materials including steel and iron from the e-waste debris.

SOLID WASTE MANAGEMENT

6. **Non-metallic and metallic components separation.** - The sixth step is the separation of metals and non-metallic components. Copper, aluminum, and brass are separated from the debris to only leave behind non-metallic materials. The metals are either sold as raw materials or re-used for fresh manufacture.
7. **Water Separation-** As the last step, plastic content is separated from glass by use of water. One separated, all the materials retrieved can then be resold as raw materials for re-use. The products sold include plastic, glass, copper, iron, steel, shredded circuit boards, and valuable metal mix.

E-cycle components re-use

1. Plastic. All the plastic materials retrieved are sent to recyclers who use them to manufacture items such as fence posts, plastic sleepers, plastic trays, vineyard stakes, and equipment holders or insulators among other plastic products.

2. Metal. Scrap metals materials retrieved are sent to recyclers to manufacture new steel and other metallic materials.

3. Glass. Glass is retrieved from the Cathode Ray Tubes (CRTs) mostly found in televisions and computer monitors. Extracting glass for recycling from CRTs is a more complicated task since CRTs are composed of several hazardous materials. Lead is the most dangerous and can adversely harm human health and the environment. Tubes in big CRT monitors can contain high levels of lead of up to 4 kilograms. Other toxic metals such as barium and phosphor are also contained in CRT tubes. To achieve the best environmentally friendly glass extraction, the following steps ensure a specialized CRT recycling:

- Manual separation of the CRT from the television or monitor body
- Size reduction process where the CRT is shredded into smaller pieces. Dust is eliminated and disposed in an environmentally friendly way.
- All metals are removal through over-band magnets, where ferrous and non-ferrous components are eliminated from the glass materials.
- A washing line is then used to clear oxides and phosphors from the glass
- Glass sorting is the final step whereby leaded glass is separated from non-leaded glass. The extracts can then be used for making new screens.

SOLID WASTE MANAGEMENT

4. **Mercury.** Mercury containing devices are sent to mercury recycling facilities that uses a specialized technology for elimination for use in dental amalgams and metric instruments, and for fluorescent lighting. Other components such as glass and plastics are re-used for manufacture of their respective products.
5. **Printed Circuit Boards.** Circuit boards are sent to specialized and accredited companies where they are smelted to recover non-renewable resources such as silver, tin, gold, palladium, copper and other valuable metals.
6. **6. Hard Drives.** Hard drives are shredded in whole and processed into aluminum ingots for use in automotive industry.
7. **Ink and Toner Cartridges.** Ink and toner cartridges are taken back to respective manufacturing industries for recycling. They are remanufactured while those that can't are separated into metal and plastic for re-use as raw materials.
8. **Batteries.** Batteries are taken to specialized recyclers where they are hulled to take out plastic. The metals are smelted is specialized conditions to recover nickel, steel, cadmium and cobalt that are re-used for new battery production and fabrication of stainless steel.

CONSTRUCTION WASTE

Construction waste is anything generated as a result of construction and then abandoned, regardless of whether it has been processed or not. It comprises surplus materials from site clearance, excavation, construction, refurbishment, renovation, demolition and road works.

Construction waste is generated from construction building and demolition activities consisting of concrete, tiles, bricks, drywall, asphalt, plastics, metals, wood, rocks and more. These construction waste materials are often inert and non-biodegradable, heavy, bulky and overload landfills.

Construction waste recycling and management involves the process and separation of salvaging the recoverable waste materials for recycling and reuse. Krause Manufacturing's innovative approach and advanced solutions to construction waste disposal and commercial waste recycling will boost your productivity and bottom line profitability.

DIFFERENT TYPES OF CONSTRUCTION WASTE

- **BUILDING MATERIALS**

Construction, demolition, restoration, and remodeling projects all produce a lot of building material waste. This waste may include insulation, nails, electrical wiring, rebar, wood, plaster, scrap metal, cement, and bricks. These materials may be damaged or unused, but can be recycled or reused in other forms. Waste wood can be recovered and recycled into wood for new building projects. Cement, bricks, and plaster can be crushed

SOLID WASTE MANAGEMENT

and reused in other construction or building projects. These materials can be collected in a roll of dumpster that can then be picked up by your waste management or recycling company.

- **DREDGING MATERIALS**

Dredging materials are materials or objects that are displaced during the preparation of a construction or demolition site. These materials may include trees, tree stumps, rubble, dirt, and rocks. A waste management company can provide waste disposal and trash removal of dredging materials. If any of these materials can be reused or recycled, they will be taken to a recycling plant. A waste management company can also provide dumpster rentals in which you can collect this waste.

- **HAZARDOUS WASTE**

The sites of construction, demolition, restoration, and remodeling projects often produce hazardous waste. Hazardous waste may include lead, asbestos, plasterboard, paint thinners, strippers, and solvents, mercury, fluorescent bulbs, and aerosol cans. These materials need to be disposed of according to strict state and federal laws, and there are harsh fines and punishments for non-compliance. A waste management company in Atlanta can help you comply with city, county, and state guidelines, as well as with your insurance requirements for the safe disposal of hazardous waste.

SOURCES OF CONSTRUCTION WASTE

- ❑ Waste from different construction activities of building roads. Consists of: -
 - ❖ Concrete
 - ❖ Brick
 - ❖ Timber
 - ❖ Sanitary ware
 - ❖ Glass
 - ❖ Steel
 - ❖ Plastics

CONCRETE

- ❖ Concrete is one of the most important construction material.
- ❖ Approximately one ton of concrete is used per capita per year through out the world
- ❖ Recycling of concrete reduces

SOLID WASTE MANAGEMENT

- ❖ Cost of aggregate
 - ❖ Disposal costs
 - ❖ Environmental damage
 - ❖ Consumption of natural resources &
 - ❖ Valuable landfill space
- ❖ Recycled coarse aggregates may be more durable than virgin material.
- ❖ It can also be used in residential construction.

BRICK

- ❖ Broken & discarded brick can be used as construction infill or as aggregate for non – structural concrete.
- ❖ Brick that are part of demolish rubble can be crushed and used in the same way.
- ❖ Brick masonry rubble contains mortar upto 20% by volume.
- ❖ Crushed brick & roofing tiles are the bulk of demolition waste which were earlier being dumped in landfills, but now they can be recycled into mortar plaster & building blocks.

notes4free.in

TIMBER

- ❖ It is mostly crushed into chip & used as fuel.
- ❖ It can also be utilized to manufacture wood –chip concrete by injecting cement grout into voids of compacted wood chips in moulds.
- ❖ Wood-chip in concrete can be used as building material.
- ❖ This chip can be sawn & nailed as well.
- ❖ In Japan alone about 12 million cubic meters of used timber from demolished houses are used.

SANITARY WARE

- ❖ Sanitary ware includes tiles also.
- ❖ There can be reused as it is, if they are not damaged.
- ❖ If sanitary where are chipped (or) cracked (or) otherwise damaged are advised to crush and use them as construction infill (or) as filler in concrete.
- ❖ Pozzolanic value of such crushed & powdered sanitary ware is a desirable property in concrete mixes.

SOLID WASTE MANAGEMENT

GLASS

- ❖ One ton of recycled waste glass corresponds to savings in energy equivalent to 125lit of fuel oil & 1.2 tonnes of raw materials
- ❖ Recycling of glass reduces non-biodegradable glass out of landfills.
- ❖ Glass can be used as substitute for Quarts & Feldspar in the manufacturing of high strength porcelain sanitary ware.
- ❖ It can also be used to make mineral wool an insulation product & in granular form as part of the aggregate in concrete mixes.
- ❖ In USA an experiment was conducted on metal free glass constituents separated from municipal incinerator residue. This glass was used to produce brick, glass-wool thermal insulation & as a major component of a light weight aggregate use in structural concrete.

STEEL

- ❖ Steel is most commonly used metal in the world.
- ❖ Steel reinforcement from demolished concrete is usually separated from the rubble on site & sold scrap to recycling plants.
- ❖ The world produces over 783 million tons of raw steel. It currently recycles over 320 million tonnes of iron & steel every year.
- ❖ Scrap metal can yield energy savings of upto 76%. **notes4free.in**
- ❖ In Europe steel is most recycled.

PLASTIC

- ❖ There is an over abundance of waste plastic.
- ❖ It is very difficult to dispose plastics.
- ❖ Waste plastic can be shredded & used as filler in other materials such as concrete & also in construction of roads.
- ❖ House hold plastic waste can be recycled to obtain artificial light weight aggregates for mortar.
- ❖ Plastic reduces the possibilities of cracking.

REASONS FOR INCREASE OF CONSTRUCTION WASTE

- ❖ Many old buildings concrete pavements bridges and other structures have overcome their age and limit of use due to structural deterioration beyond repairs and need to be demolished.

SOLID WASTE MANAGEMENT

- ❖ New construction for better economic growth.
- ❖ Structures are turned into debris resulting from natural disasters like earthquake, cyclone and floods etc.

COLLECTION OF CONSTRUCTION WASTE

The construction and demolition waste include waste forming during construction, reconstruction, repairs or demolition of buildings, also a construction product waster.

- ❑ Construction and big-sized waste forming during construction, repairs or demolition of buildings may be collected in three ways: -
 - ❖ On special routes: according to a schedule settled in advance waste is collected from yards of apartment buildings and sites of domestic waste containers located near buildings;
 - ❖ In construction waste containers: special metal containers are placed in residential or commercial areas or building lots. Their capacity may amount to from 5 up to 20 cbm. Full containers are replaced by empty ones;
 - ❖ In big-bags: this pre-payable service is especially important to individuals or enterprises, holding low amounts of construction or big-sized waste – those who are repairing their homes or willing to get rid of unnecessary things. Also, to those who are not willing to hire a construction container or have no place for it.

SOLID WASTE MANAGEMENT

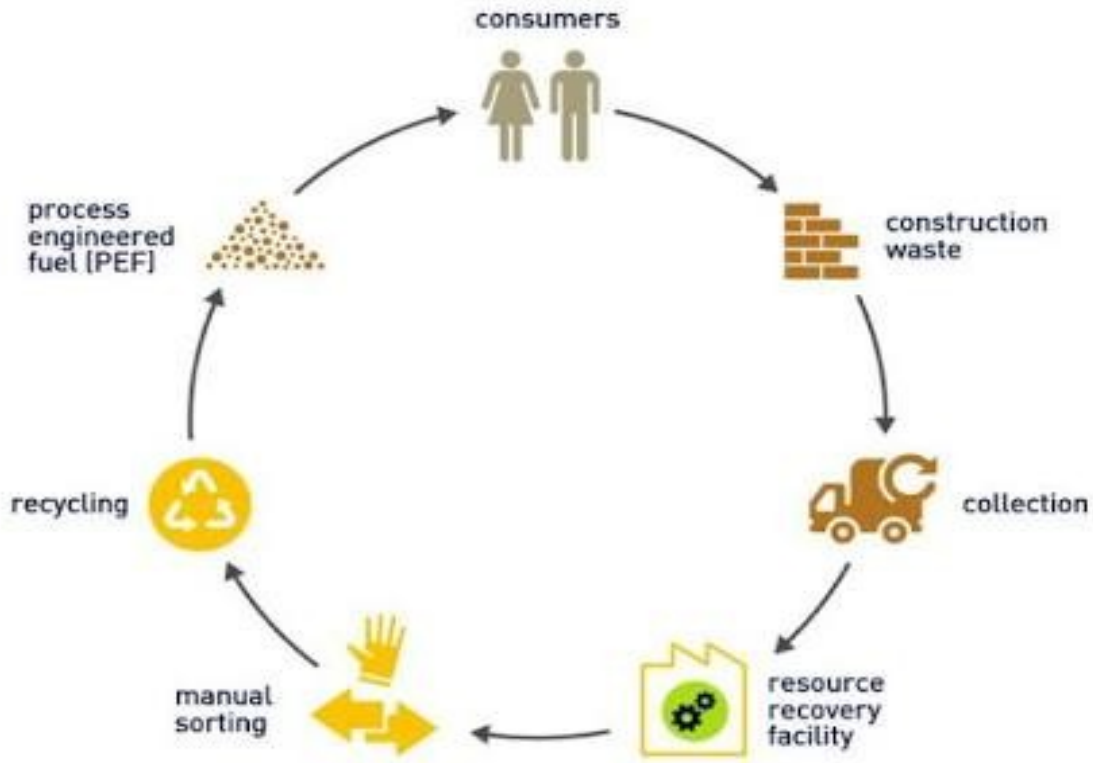

notes4free.in

TREATMENT OF CONSTRUCTION WASTE

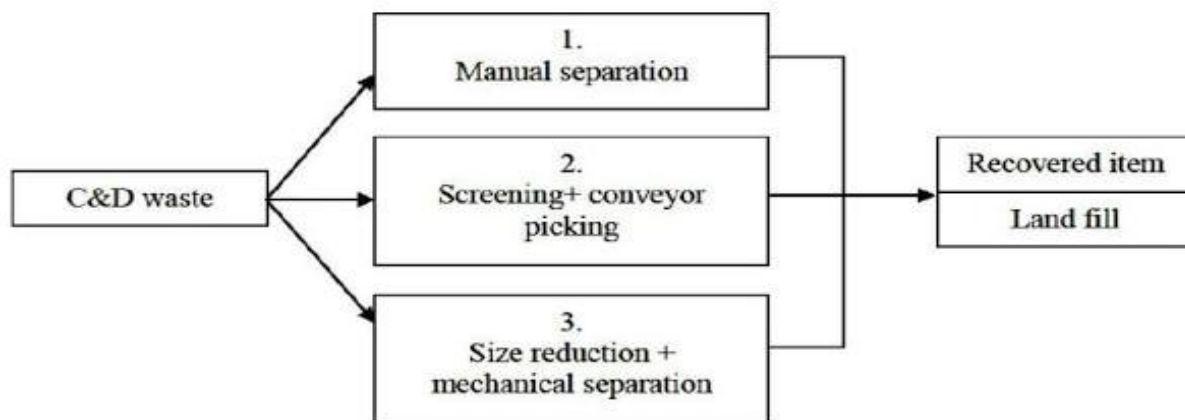

Details of the treatment method : Refer previous Module Notes

DISPOSAL OF CONSTRUCTION WASTE

SOLID WASTE MANAGEMENT

- ❖ Being predominantly inert in nature, construction and demolition waste does not create chemical or biochemical pollution
- ❖ The material can be used for filling/levelling of low-lying areas.
- ❖ In the industrialised countries, special landfills are sometimes created for inert waste, which are normally located in abandoned mines and quarries.
- ❖ The same can be attempted in our country also for cities, which are located near open mining quarries or mines where normally sand is used as the filling material.

However, proper sampling of the material for its physical and chemical characteristics has to be done

notes4free.in

BIOMEDICAL WASTE

Biomedical waste is any kind of waste containing infectious materials. It may also include waste associated with the generation of biomedical waste that visually appears to be of medical or laboratory origin (e.g., packaging, unused bandages, infusion kits, etc.), as well research laboratory waste containing biomolecules or organisms that are restricted from environmental release.

Biomedical waste may be solid or liquid. Examples of infectious waste include discarded blood, sharps, unwanted microbiological cultures and stocks, identifiable body parts, other human or animal tissue, used bandages and dressings, discarded gloves, other medical supplies that may have been in contact with blood and body fluids. Waste sharps include potentially contaminated used (and unused discarded) needles, scalpels, lancets and other devices capable of penetrating skin.

Biomedical waste is generated from biological, medical sources and activities, such as the diagnosis, prevention, or treatment of diseases. Common generators (or producers) of biomedical waste include hospitals, health clinics, nursing homes, emergency medical services, medical

SOLID WASTE MANAGEMENT

research laboratories, offices of physicians, dentists, and veterinarians, home health care, and morgues or funeral homes.

- **Eight Categories of Bio Medical Waste**

It's important to know what kind of medical waste your facility produces then you can determine the proper disposal.

The WHO classified the medical waste into eight (8) categories of medical waste:

1. **Infectious waste** – Waste that may transmit infection from virus, bacterial, parasites to human, i.e.: lab cultures, tissues, swabs, equipment and excreta
2. **Sharps** – Sharp waste, such as needle, scalpels, knives, blades, etc.
3. **Pathological** – Human tissue or fluids i.e. body parts, blood, other body fluids
4. **Radioactive** – Unused liquid in radiotherapy or lab research, contaminated glassware, etc.
5. **Chemical** – Expired lab reagents, film developer, disinfectant
6. **Pharmaceuticals** – Expired and contaminated medicines
7. **Pressurized containers** – Gas cylinders and gas cartridges
8. **General waste (UMW)** – No risk to human health because no blood or any related bodily fluid, i.e.: office paper, wrapper, kitchen waste, general sweeping, etc.

Stages of Medical Waste Disposal





Stage 1 – Collecting & Segregating

The biomedical waste has to be collected in containers that are resilient and strong from breakage during the handling process. Do not place sharps, used needles, syringes, or other contaminated tools in common waste disposal or recycle bin because the entire waste will be infectious by doing so. The segregation also needs to be performed between the liquid and solid biomedical waste products. Categorizing the medical waste with correct segregation to isolate and manage each waste in the proper way. For this purpose, the segregations come in colored waste containers, label coding and plastic bags.

SOLID WASTE MANAGEMENT

Storage of waste

Storage refers to keeping the waste until it is treated on-site or transported off-site for treatment or disposal. There are many options and containers for storage. Regulatory agencies may limit the time waste can remain in storage. Handling is the act of moving biomedical waste between the point of generation, accumulation areas, storage locations and on-site treatment facilities. Workers who handle biomedical waste must observe *standard precautions*

SHARPS Red Sharps Container	BIOHAZARD Red Container or Red Liner in Container	TRACE CHEMO Yellow Container
<ul style="list-style-type: none">✓ Needles✓ Ampules✓ Broken Glass✓ Blades✓ Razors✓ Staples✓ Trocars✓ Guide Wires✓ Other Sharps 	<ul style="list-style-type: none">✓ Infectious Waste✓ Blood Products (albumin, etc)✓ Contaminated Personal Protective Equipment (PPE)✓ IV Tubing✓ Cultures, Stacks  <p>notes4free.in</p>	<ul style="list-style-type: none">✓ Empty vials, ampules✓ Empty Syringes, Needles✓ Empty IVs✓ Gowns✓ Gloves✓ Tubing✓ Aprons✓ Wipes✓ Packaging 
RCRA HAZARD Black Container	PHARMACEUTICAL Blue Container	RADIOACTIVE Shielded Containers with Radioactive Symbol
<ul style="list-style-type: none">✓ Hazardous meds (RCRA)✓ Half/Partial doses (RCRA)✓ Hazardous bulk meds✓ P-listed drugs, packaging✓ Bulk chemo✓ Pathological Waste (Incineration Only) 	<ul style="list-style-type: none">✓ Pills✓ Injectables✓ Antibiotics 	<ul style="list-style-type: none">✓ Fluorine-18 (F-18). 110 minutes half-life.✓ Technetium-99 (T-99m). 6 hours half-life.✓ Iodine-131 (I-131). 8 days half-life.✓ Strontium-89 (Sr-89). 52 days half-life.✓ Iridium-192 (Ir-192). 74 days half-life.✓ Cobalt-60 (Co-60). 53 years half-life. 

SOLID WASTE MANAGEMENT

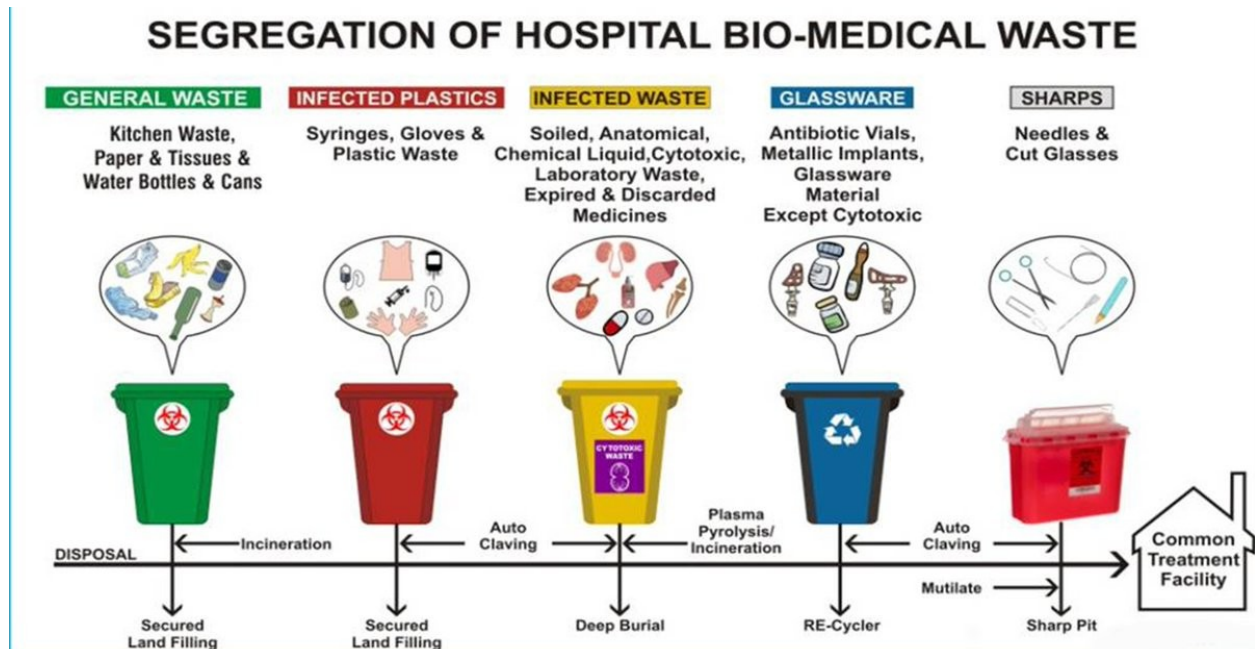

Generation and accumulation notes4free.in

Biomedical waste should be collected in containers that are leak-proof and sufficiently strong to prevent breakage during handling. Containers of biomedical waste are marked with a biohazard symbol. The container, marking, and labels are often red.

- Discarded sharps are usually collected in specialized boxes, often called *needle boxes*.

Sources of Biomedical waste

Major Sources

- Government Hospitals, private hospitals & Nursing homes
- Primary Health centers
- Medical Colleges and Research centers
- Veterinary Colleges and animal Research centers

SOLID WASTE MANAGEMENT

- Blood Bank & mortuaries
- Biotechnology Institutions

Treatment

The goals of biomedical waste treatment are to reduce or eliminate the waste's hazards, and usually to make the waste unrecognizable. Treatment should render the waste safe for subsequent handling and disposal. There are several treatment methods that can accomplish these goals.

5 Ways of Treating Medical Waste

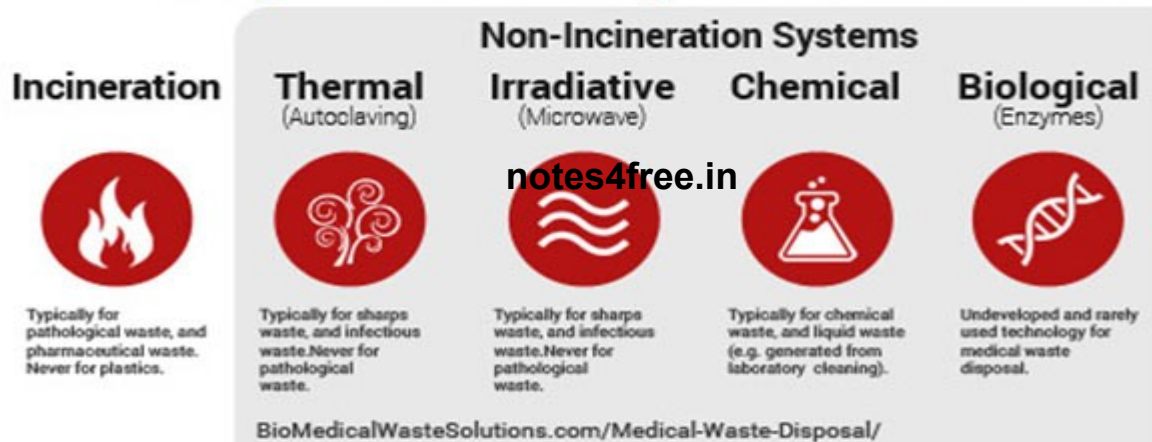

Biomedical waste is often [incinerated](#). An efficient incinerator will destroy pathogens and sharps. Source materials are not recognizable in the resulting ash.

1. INCINERATION

Type 1 of Medical Waste Treatment The incineration technology used a high temperature thermal process that can convert inert material and gases with the combustion process. It will process the waste to convert into ash, gas, and heat. There are three types of incinerators that are commonly used for biomedical waste:

SOLID WASTE MANAGEMENT

1. **The Multiple Hearth Type**– it has a circular steel furnace that contains solid refractory hearths with a central rotating shaft to convert the waste into ash
2. **Rotary Kiln** – it is an incinerator, shape like a drum, commonly for medical and hazardous waste
3. **Controlled Air** – there are two process chambers that will handle the waste. The complete combustion and oxidizing it, leading to a stream of gas with carbon dioxide and water vapor composition. It is commonly used for waste that has organic materials.

In addition, for some cases, performing a shredding for biomedical waste needed as an aid for incineration process.

2. AUTOCLAVE

An autoclave may also be used to treat biomedical waste.

1. The **autoclaving system** is commonly used for the human body fluid waste, sharps, and microbiology laboratory waste. This system requires high temperature (thermal) that produces steam to decontaminate the biomedical waste.
2. An autoclave uses steam and pressure to sterilize the waste or reduce its microbiological load to a level at which it may be safely disposed of. The steam plays a critical role in the medical waste autoclaving process therefore a good waste holding container is required.
3. Beside autoclaving, **irradiation** is the other thermal method which uses a high frequency microwave for disposal. The wave will generate heat to the waste materials and kill all the bacteria, or any other contamination in the tools. Many healthcare facilities routinely use an autoclave to sterilize medical supplies.

3. MICROWAVE DISINFECTION

Microwave disinfection can also be employed for treatment of Biomedical wastes.

- Microwave irradiation is a type of non-contact heating technologies for disinfection. When exposed to microwave frequencies, the dipoles of the water molecules present in cells re-align with the applied electric field.

SOLID WASTE MANAGEMENT

- As the field oscillates, the dipoles attempts to realign itself with the alternating electric field and in this process, energy is lost in the form of heat through molecular friction and dielectric loss.
- Microwave disinfection is a recently developed technology which provides advantage over old existing technologies of autoclaves as microwave based disinfection has less cycle time, power consumption and it requires minimal usage of water and consumables as compared to autoclaves.
- For liquids and small quantities, a 1–10% solution of bleach can be used to disinfect biomedical waste. Solutions of sodium hydroxide and other chemical disinfectants may also be used, depending on the waste's characteristics. Other treatment methods include heat, alkaline digesters and the use of microwaves.

Disposal

For solid waste, once medical waste producers have adhered to regulations for collecting, storing, transporting, and treating their waste, they may then use their municipal landfill and sanitary sewer system as their final disposal method.

That's right, your local municipal landfill is often used as the final place of your treated decontaminated biomedical waste.

For fluids such as blood, suctioned fluids, excretions and secretions, almost **every state and local government** has its own regulations and guidelines to provide the best way to dispose it.

In general, there are two recommended ways to handle medical waste fluids:

1. Collect fluids in a leak proof container, and solidified for autoclave treatment
2. Thermally (autoclave) fluids then they be disposed into the sanitary sewer system

An extra precaution should be performed before pouring treated fluids in sewer because they may clog and leak.

SOLID WASTE MANAGEMENT

MODULE-5

Incineration can be defined as the controlled combustion process for burning of solid, liquid waste to residue containing non-combustible materials.

Incineration is one of the chemical process used to reduce the volume of the solid waste. This process is also called as chemical volume reduction. At present it is one of the common method used to reduce the volume of waste chemically. chemical process such as pyrolysis, hydrolysis and chemical conversion are also effective in reducing the volume of waste.

Normally all the combustible matters such as garbage rubbish and dead animals are burnt and the incombustible matters like chinaware, glass, metals etc are left unburnt or separated out for recycling and reuse before the burning of solid wastes.

Advantages

1. Incineration causes a significant reduction in the volume of waste. The reduction in the original volume and weight 95% and 75% respectively.
2. It helps providing a renewable source and conserving valuable raw materials.
3. Bottom ash can be reused – as secondary aggregates for parking lots, paved roads etc.
4. Due to incineration, a large proportion of the organic compounds including putresible and hazardous waste is destroyed. So there is a net reduction in the quantity of toxicity.
5. Incineration does not does not generate methane gas and reduces methane from landfills.
6. It provides better control over odour and noise.
7. It occupies small land.

Disadvantages of Incineration

The disadvantages of incineration are as follows.

1. It causes atmospheric pollution if incinerators are not ell maintained.
2. Incinerators are costly to construct, operate and regulate. Stringent emission for incinerators increase the cost of construction, operation and maintenance.
3. It lacks system flexibility. The demand for recycled and recovered material for different treatment methods is likely to change overtime.
4. Incineration process produces ash and waste water from pollution control devices.

SOLID WASTE MANAGEMENT

5. A huge amount of money required to purchase a foreign made incinerator.
6. Low income countries often lacks of adequately trained labor to operate and maintain incinerator systems.

Factors affecting Incineration process

- **Pressure:** Incineration operations are designed to operate at slightly -ve pressure to reduce unwanted gases.
- **Air supply:** Incineration operation involves the reaction of combustible components with air. Air provides oxygen for the incineration process. Typical incineration process requires sufficient oxygen to ensure complete combustion.
- **Use of refractory materials:** The thermal destruction system must be insulated with refractory materials to effectively operate at high temperature. The main purpose of refractory materials is to contain within the unit the heat released from the incineration process, proper containment of this energy is desirable for optimal vaporization & combustion of waste.
- **Materials of construction:** Normally ordinary steel or alloys are used as materials of construction for incinerators. Required temperature can be maintained in the incinerators by the proper selection of materials of construction

notes4free.in

PYROLYSIS

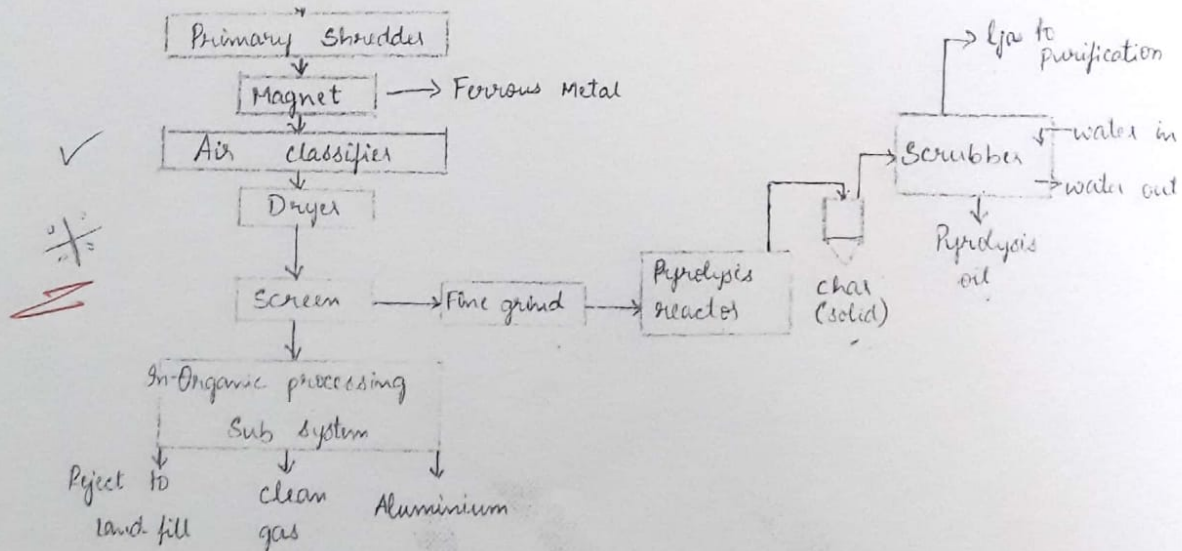

SOLID WASTE MANAGMENT

Pyrolysis is the thermal process of converting the solid waste into gaseous, liquid & solid fractions, thus a combination of thermal cracking & condensation reaction.

Pyrolysis is widely used as an industrial process for the production of charcoal from wood coke & coke gas from coal, fuel gas from heavy petroleum fractions.

The three major components resulting from pyrolysis process are

- Gas stream consisting primarily of hydrogen, methane, carbon monoxide, carbon dioxide and various other gases depending on the organic characteristics of materials.
- Liquid fraction consisting of tar/oil stream contains acetic acid, acetone, methanol & complex hydrocarbon
- Solid fraction - Pure char consisting of almost pure carbon and any inert materials originally present in the solid waste.

This system employs stages of shredding, air classification, drying to produce a very fine organic fraction. Inorganic fraction is rejected to landfill site. Ferrous metals, aluminum & glass are recovered by magnetic separation. The pyrolysis portion consists of several interconnected loops. The end products are pyrolytic oil, gases, char & ash.

Limitations

notes4free.in

- Inherent complexity of the system.
- Lack of appreciation by system designers of the difficulties of producing a consistent feed stock from municipal solid waste.
- They never produce design and operational data that can be used by future designs.

SOLID WASTE MANAGEMENT

TYPES OF INCINERATORS

FLUIDIZED BED INCINERATOR

In this system, generally the source separation is carried out because glass and metals do not fare well in these systems and also they can successfully burn wastes of widely varying moisture and heat content, so that the inclusion of paper and wood, which are both recyclable and burnable.

The system is comparatively of modern origin & consists of furnace or reactor having silica sand filled in its bottom portion.

- Fluidized system consist of vertical steel cylinder usually refractory lined with a sand bed a supporting and air injection nozzle known as tuyeres.
- This structure has a series of layer which allow the passage of air upward towards the sand bed.
- The sand bed is kept in fluid condition by creating turbulence by upward flow of air to be passed under a pressure of about 25 to 35kpa
- The sand bed is also preheated to approximately 650°C by using fuel oil or gas.
- The depth of sand bed in a fluid bed incinerator may usually vary from 0.6 to 4m.
- High sludge solid waste followed by low sludge waste is burnt in the incinerator.
- Water is supplied in the incinerator for the combustion process.
- Hot air is then passed into the heater where in particulate matters are removed from the air and some part of the air is again recycled into the incinerator and rest is left into the

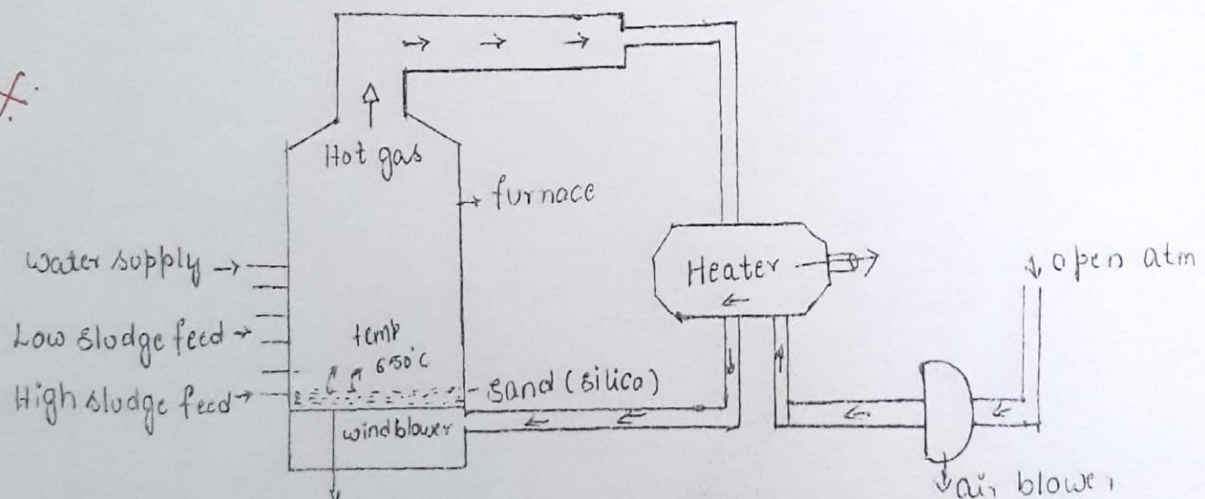

SOLID WASTE MANAGMENT

open atmosphere

MERITS

- This is the most hygienic method since it ensures complete destruction of pathogens.
- There is no odor trouble or dust sense. The heat generated can be used for generation of steam power.
- Adverse weather conditions have no effect on the Incinerators.

DEMERITS

- It is very costly method & requires technical person to handle the instruments.
- Improper operation result in air pollution problem& in complete reduction of the waste materials.
- Disposal of remaining residue is required.

notes4free.in

* Types of Incinerators

1. Rotary Kiln Incinerator:-

Solid waste as well as liquid waste generated by industry are destroyed by on site and commercial site Rotary Kiln incinerator system.

- The Rotary Kiln is a cylindrical refractory-lined shell that is rotated to provide tumbling and lifting action to the solid waste materials.
- Rotary Kiln incinerator like other types, are designed with
 - i) A primary chamber where the waste is heated and volatilized
 - ii) A Secondary chamber, where combustion of the volatile fraction is completed.
- The primary chamber consist of slightly inclined, in which waste materials migrate from the feed end to the ash discharge end.
Nozzles/
- Openings are provided to input solid & liquid waste, fuel & air for burning of waste. Flames are generated over the surface of waste solids exposed to the heat & incoming air. Temperature for burning varies from 1,300 to 2400°F, in which the wastes are volatilized and oxidized in primary chamber.
- The unburnt volatiles enter the Secondary chamber along with the hot products of combustion, where additional oxygen is introduced and

ignitable liquid waste or fuel can be burned.

- Ashes from the primary & Secondary chamber is discharged out. The temp of the ash discharged by the kiln is lower. This creates less issues with slagging and is therefore more reliable and less complex. No need of water bath for cooling slag and discharge. Metal recovery from the ashes is also possible.

Rotary kiln incinerator

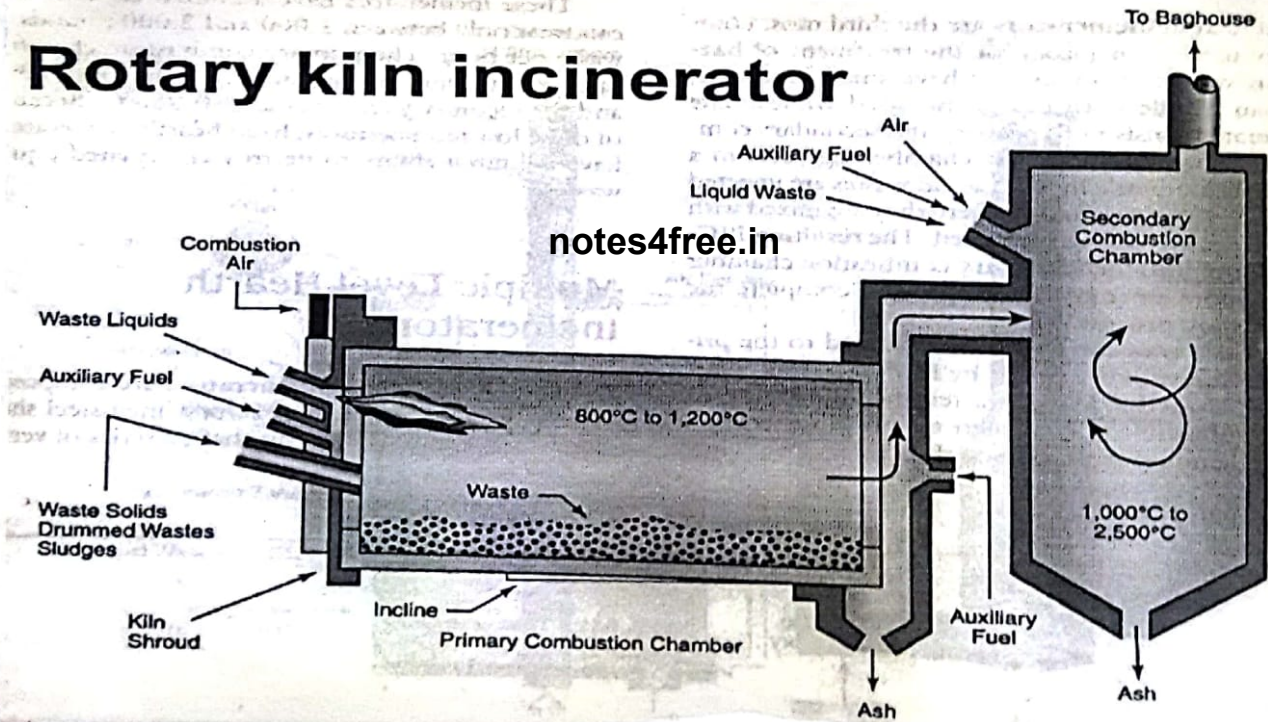

* Liquid Injection Incinerator :-

It is used primarily in chemical industry to destroy the liquid waste that contains organic toxins.

- It is commonly used system that relies on high pressure to prepare liquid wastes for incineration.
- This Incinerator furnace is lined inside with firebrick & temperature of usually 1000°C & higher is maintained.
- Wastes are sent through nozzles, along with wastes, fuel is added to reach the desired temperature.
- Liquid sent into the nozzle will be exposed to burner flames & is atomized into small droplets to allow for the greatest possible mixing with air.
- The operating temperature varies from $1200-3000^{\circ}\text{F}$.
- Can completely combust non combustibles like contaminated water, along with organic combustible materials.
- Toxic liquid waste gets oxidized to produce CO_2 , H_2O , O_2 , N_2 & acid gases.
- Acid gases must be cleaned from exhaust stream by using wet scrubbers.

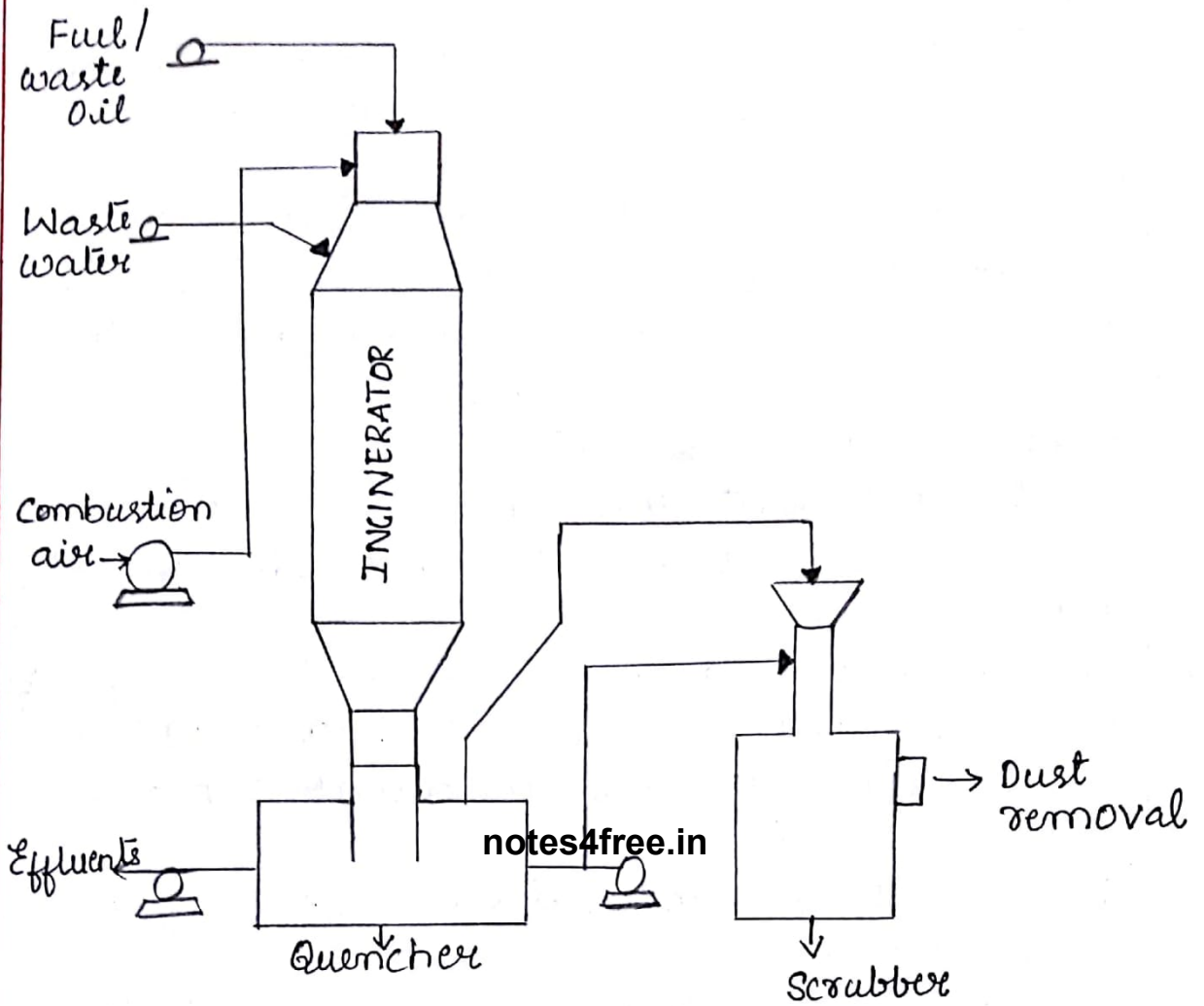

* Catalytic Incinerator :-

Catalytic Incinerator is a oxidation process which oxidizes volatile organic compounds by using catalyst to promote the combustion process.

Catalytic Incinerator require lower temperature, thus saving fuel & other costs.

- Catalytic Incinerator are used to destroy gaseous pollutants in Volatile organic compounds.

Catalyst used may be platinum, oxides of copper in the

A catalytic Incinerator may consist of the following components :-

porous, honeycomb or wire mesh.

1. A pre heater section
2. A burner
3. A mixing chamber
4. A catalyst bed
5. A blower

notes4free.in

Process :-

1. An incoming pollutant gas stream may be preheated prior to feeding the same into the mixing chamber.
2. In mixing chamber, the gas stream gets mixed with the hot flue gas from the burner so that the mixture may attain the temperature at which catalytic oxidation would take place.
3. The purpose of the burner would be to produce the heat required to maintain in mixing chamber and the catalyst bed. The fuel may be either gas or an oil.

~~copy~~

- The catalyst bed is arranged in such a fashion that the influent stream admixed with hot flue gas has to pass through the bed & no portion may bypass the bed. It should be so fitted to the combustion chamber that the same may be easily taken out for reactivating or replacement.
- Complete destruction of the pollutants present in a waste gas stream is difficult to achieve in an incinerator. 98-99% destruction may bring down the pollutant concentration to permissible limit. Most of the Volatile Organic Compound on complete combustion^{to} produce CO_2 & H_2O . Some of the pollutants like SO_2 , SO_3 , halogens are also obtained.

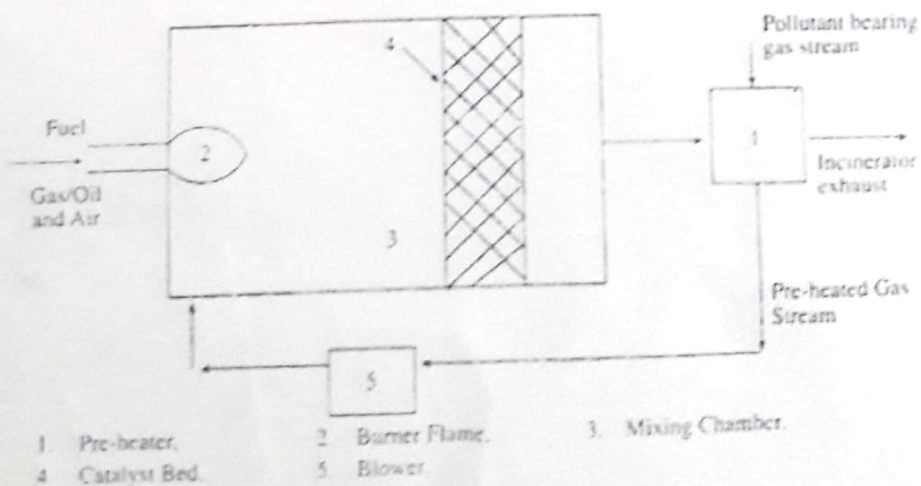

Fig. 4.17 : Schematic Diagram of a Catalytic Incinerator

* Multiple hearth Incinerator :-

- The multiple hearth incinerator is a flexible unit that has been utilized to dispose of sewage sludge, solids and liquid combustible waste.
- A multiple hearth furnace includes a refractory lined steel shell, a central shaft that rotates, a series of solid flat hearths, a series of rabble arms with teeth for each hearth, a combustion air blower, fuel burners mounted on the walls, a ash removal system and a waste feed system.
- In vertically oriented, cylindrical style multi hearth furnaces, ~~water~~ water sludge is fed into the perimeter of the top of hearth.
- Due to gravity and rabble arms move the sludge progressively downwards through the hearths towards an ash discharge below the last hearth.
- Multiple hearth furnaces can typically be considered to consist of three zones.
The upper hearth comprise the drying zone where most of the moisture in the sludge is evaporated. The temperature in the drying zone is typically between 425°C - 760°C .
- Sludge combustion occurs in middle hearth (Second zone) as the temperature is increased to about 925°C .

- The combustion zone can be further sub-divided into ^{upper} middle hearths, where volatile gases & solids are burned & lower middle hearths, where most of the fixed carbon is burned.
- The third zone, made up of lower hearths is the cooling zone. In this zone, the ash is cooled as its heat is transferred to the incoming combustion air.

* Disadvantages:-

- Due to the longer residence times of the waste materials, temperature response throughout the incinerator when the burners are adjusted is usually very slow. notes4free.in
- It is difficult to control the firing of supplemental fuel as a result of this slow response.
- Maintenance cost is high.
- This device is not suitable for wastes containing fusible ash, waste that require extremely high temperature for destruction or irregular bulky solids.

* Energy Recovery Operations

- Once the solid waste has been converted to thermal energy in the form of steam by combustion or to chemical energy in the form of gases or liquid by pyrolysis or gasification, it can be converted to mechanical or electrical energy.
- Steam can be used to produce mechanical or electrical energy by a steam engine/turbine.
 - Gases & liquid produced from solid waste by both thermal and biological processes can be used in fuel boilers to produce steam.

The purpose of Energy Recovery Operation is as follows

- To present basic flow diagram available for accomplishing these conversions.
- To present data on the efficiency of components used in the various conversion process.
- To illustrate the use of efficiency data in computing energy outputs.

* Energy Recovery Flow diagram:- - Recovery Techniques

The principle components used for energy recovery are boilers for steam production, steam turbines, gas turbines and reciprocating engines as prime movers for mechanical energy, electric generators for the conversion of mechanical energy into electricity.

* Stream Turbine System:-

- The most common energy recovery system for the production of electricity is the stream turbine system.
- Steam is produced in a boiler by burning of municipal solid waste.
- Steam is used to drive a steam turbine and then condensed back into boiler feed system.
- The steam turbine drives an electrical generator, which supplies on site power and excess power for export.

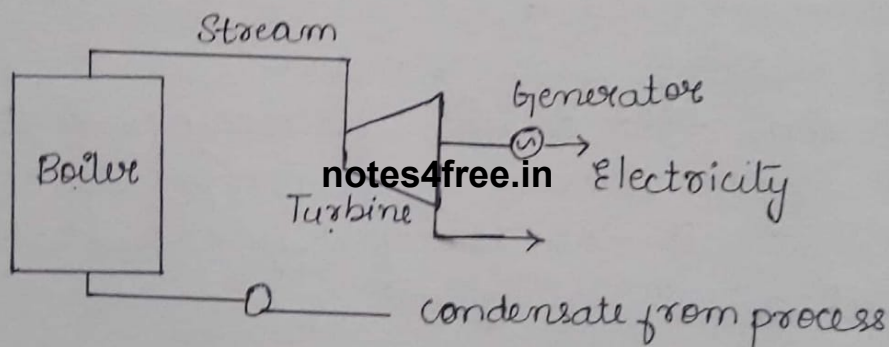

* Gas Turbine Generator system

- Gas turbines requires gaseous or liquid fuel.
- These fuel can be supplied by biological processes such as landfill gas or by the anaerobic process or by pyrolysis.
- A gas turbine is similar to a jet engine.
- In that it consist of a compressor section to increase the density of gas/air mixture, a combustor and a turbine section to convert the hot combustion gases to mechanical energy.

- An electrical generator is connected directly to the output shaft of the gas turbine.
- Gas turbines are efficient and compact & are widely used in Landfill gas system.

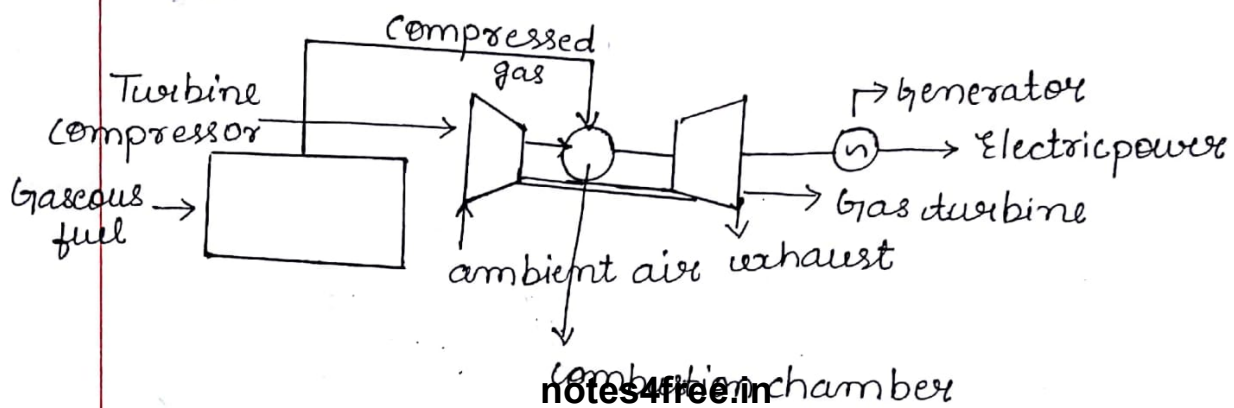

* Internal Combustion Engine system.

* Co-generation System :-

Cogeneration refers to combined production of steam and electricity & can occur in two ways.

- Cogeneration systems are widely used in industries to generate electricity & process or building heat at the same time.
- In cogeneration, high pressure steam is used first to generate electricity, the steam leaving the turbine is then used to serve the steam users.
- Solid waste is combusted in Incinerator. The end products obtained after the combustion process is Ash residue & Flue gases. Ash residue is then sent to sanitary landfill for further treatment.
- Flue gas is then [notes4free.in](https://www.notes4free.in) into boiler for the production of steam. Then the steam is sent into Extraction steam turbine, from turbine to electric generator for the production of electricity.

- Cogeneration System for producing Electricity & steam

